



**WORLD
SKATE**

RULES OF THE GAME & TECHNICAL REGULATION

WORLD SKATE - RINK HOCKEY TECHNICAL COMMISSION



**WORLD
SKATE**



RULES OF THE GAME & TECHNICAL REGULATION - SUMMARY / INDEX

CHAPTER I - THE GAME OF RINK-HOCKEY - DEFINITION AND SCOPE		
Article 1	THE GAME OF RINK-HOCKEY	Page 2
Article 2	REGULAR PLAYING TIME	Page 2
Article 3	GAME TIED - PROCEDURES TO CONSIDER	Pages 3 to 5
Article 4	POINT SYSTEM, CLASSIFICATION AND TIE-BREAKER CRITERIA	Pages 5 and 6
Article 5	NO-SHOW AND ABANDONMENT OF THE MATCH	Pages 6 and 7
Article 6	MATCH PRELIMINARY ACTS AND PROCEDURES	Pages 7 to 9
CHAPTER II - CATEGORIES OF PLAYERS - RINK-HOCKEY TEAMS		
Article 7	CATEGORIES OF PLAYERS, PER GENDER AND AGE	Page 10
Article 8	COMPOSITION OF THE RINK-HOCKEY TEAMS	Pages 11 and 12
Article 9	RESERVE BENCH FOR THE TEAM REPRESENTATIVES	Pages 12 and 13
CHAPTER III - REFEREEING TEAM AND OFFICIAL TABLE OF THE GAME		
Article 10	REFEREEING TEAM AND TIME-KEEPING	Pages 14 to 17
Article 11 -	ABSENCE OR SUBSTITUTION OF THE APPOINTED REFEREES - PROCEDURES	Pages 17 and 18
Article 12	REFEREEING PERFORMANCE EVALUATION - THE TECHNICAL DELEGATES	Pages 18 and 19
Article 13	MATCH CONTROL THROUGH AUXILIARY ELECTRONIC EQUIPMENT	Pages 19 to 20
Article 14	OFFICIAL TABLE OF THE GAME - COMPOSITION	Page 21
CHAPTER IV - PLAYING ZONES, PASSIVE PLAY AND ANTI-PLAY		
Article 15	PLAYING ZONES - DEFENITION OF PASSIVE PLAY AND OF ANTI-PLAY	Pages 22 to 24
Article 16	TIME-OUTS	Page 24
CHAPTER V - REFEREEING DISCIPLINARY ACTION		
Article 17	DISCIPLINARY SANCTIONS OF THE TEAM REPRESENTATIVES	Pages 25 and 26
Article 18	DISCIPLINARY SANCTIONS OF THE TEAMS - TO "PLAY IN INFERIORITY"	Pages 26 to 28
CHAPTER VI - SPECIFIC SITUATIONS OF THE GAME		
Article 19	STARTING AND RESTARTING OF THE MATCH	Page 29
Article 20	ENTERING AND LEAVING THE RINK - PLAYERS SUBSTITUTION	Pages 29 to 31
Article 21	GOALKEEPERS' ACTION IN THE GAME	Page 32
Article 22	PLAYING THE BALL - SPECIFIC RULES	Pages 33 and 34
Article 23	OBTAINING AND VALIDATING A GOAL	Pages 34 and 35
Article 24	BLOCKING AND OBSTRUCTION	Pages 35 and 36
Article 25	OTHER SPECIFIC SITUATIONS OF PLAY	Pages 36 to 38
CHAPTER VII - FOULS AND THEIR PUNISHMENT - ADVANTAGE RULE		
Article 26	TYOLOGY OF FOULS AND INFRACTIONS - ADVANTAGE RULE	Pages 39 and 40
Article 27	SANCTIONING OF THE FOULS - GENERAL RULES	Pages 40 to 43
Article 28	FAULTS COMMITTED OUTSIDE OF THE RINK	Pages 43 and 44
Article 29	TECHNICAL FOULS	Page 44
Article 30	VERBAL WARNINGS	Page 45
Article 31	TEAM FOULS	Pages 46 and 47
Article 32	SERIOUS FOULS / BLUE CARD FOULS	Pages 47 and 48
Article 33	VERY SERIOUS FOULS / RED CARD FOULS	Page 48
CHAPTER VIII - TECHNICAL SANCTIONS OF THE TEAMS		
Article 34	INDIRECT FREE HIT	Pages 49 and 50
Article 35	DIRECT FREE HIT AND PENALTY	Pages 50 to 55
CHAPTER IX - REFEREEING ERRORS - CLAIMS AND/OR PROTESTS		
Article 36	REFEREEING ERRORS - CORRECTION PROCEDURES	Page 56
Article 37	MATCH COMPLAINT AND/OR PRESENTATION OF PROTESTS	Page 57
CHAPTER X - FINAL AND TRANSITIONAL PROVISIONS		
Article 38	APPROVAL, ENTRY INTO FORCE AND FUTURE CHANGES	Page 58
Annex	RINK-HOCKEY TECHNICAL REGULATION	Pages 59 to 83



CHAPTER I - THE GAME OF RINK-HOCKEY - DEFINITION AND SCOPE

ARTICLE 1 - THE GAME OF RINK-HOCKEY

1. The game of Rink-Hockey is played on a rectangular rink with a level and smooth surface, between two teams of five (5) players each, one of which is the goalkeeper.
2. The players must wear four-wheeled quad skates and use a stick to play the ball and to intent to score a goal, by introducing the ball inside the cage of the opponent team, exclusively with the help of the stick.
3. Each team starts by occupying one of the halves of the rink, **in accordance with what is established in paragraph 2 of Article 6 of these Rules**, changing position in the second period, after rest.
4. Matches are played on indoor or outdoor rinks, in most weather conditions, by day or night, with natural or artificial light.
5. One or two MAIN REFEREES are in charge of enforcing the Rules of the Game. They are assisted by and AUXILIARY REFEREE, officially designated, who directs the OFICIAL TABLE OF THE GAME, which is situated centrally, outside the rink, near to the fence.

ARTICLE 2 - REGULAR PLAYING TIME

1. Safeguarding what is established in the following paragraph, in the **UNDER 17 FEMALE category**, the effective playing time of the game is forty (40) minutes, divided into two periods of twenty (20) minutes.
 - 1.1 In competitions under the jurisdiction of a Continental Confederation - *or of any of its affiliated Federations* - a useful playing time of thirty (30) minutes, divided into two periods of fifteen (15) minutes can be established for the **UNDER 17 FEMALE** category.
2. Safeguarding what is established in the following point, in the **SENIOR FEMALE category**, the effective playing time of the game is fifty (50) minutes, divided into two periods of twenty-five (25) minutes.
 - 2.1 In competitions under the jurisdiction of a Continental Confederation - *or of any of its affiliated Federation* - a useful playing time of fifty (50) minutes, divided into two periods of twenty-five (25) minutes can be established for the **SENIOR FEMALE** category.
3. In the **UNDER 15 MALE category**, the effective playing time of the game is ~~forty~~ thirty (30) minutes, divided into two periods of fifteen (15) minutes.
4. Safeguarding what is established in the following point, in the **UNDER 17 MALE category**, the effective playing time of the game is forty (40) minutes, divided into two periods of twenty (20) minutes.
 - 4.1 In competitions under the jurisdiction of a Continental Confederation - *or of any of its affiliated Federation* - a useful playing time of thirty (30) minutes, divided into two periods of fifteen (15) minutes can be established for the **UNDER 17 MALE** category.
5. Safeguarding what is established in the following point, in the **UNDER 19 MALE category**, the useful time of the game is fifty (50) minutes, divided into two periods of twenty-five (25) minutes.
 - 5.1 In competitions under the jurisdiction of a Continental Confederation - *or of any of its affiliated Federation* - a useful playing time of forty (40) minutes, divided into two periods of twenty (20) minutes can be established for the **UNDER 19 MALE** category.
6. Safeguarding what is established in the following point, in the **UNDER 23 MALE category** and in the **SENIOR MALE category**, the useful time of the game is fifty (50) minutes, divided into two periods of twenty-five (25) minutes.
 - 6.1 In competitions under the jurisdiction of a Continental Confederation - *or of any of its affiliated Federation* - a useful playing time of forty (40) minutes, divided into two periods of twenty (20) minutes can be established for the **UNDER 23 MALE category** and in the **SENIOR MALE category**.
7. In all the above-referred categories there is a 10(ten) minutes interval, between the end of the first period and the start of the second period of play.



ARTICLE 3 - GAME TIED - PROCEDURES TO CONSIDER

Whenever a game ends in a tie and it is necessary to determine which the winning team is, the Main Referees will proceed as follows.

1. EXTRA-TIME TO UNTIE THE GAME

- 1.1 A player who is still serving suspension at the end of regular playing time must serve her/his full suspension time before being allowed to participate in the extra-time.
- 1.2 In all categories, there is a 3 (three) minutes interval between the end of regular playing time and the start of extra-time, with each team occupying the same half defensive zone they had used in the first period of the match and unable to go to their dressing rooms.
- 1.3 Extra-time will have the following duration:
 - 1.3.1 In the categories of MALE UNDER 15, MALE UNDER 17 and FEMALE UNDER 17, the extra-time will have a useful playing time of six (6)minutes, divided into two (2)periods of three (3)minutes each:
 - 1.3.2 In ALL THE OTHER CATEGORIES, extra-time is ten (10)minutes, divided over two periods of five (5)minutes each.
- 1.4 At the end of the first extra-time period, two (2)minutes interval is granted, during which the teams must stay in the rink and unable to go to their dressing rooms, switching the sides occupied on the rink and on the "reserve bench".

2. TIE-BREAKER OF THE MATCH - EXECUTION OF ONE OR MORE PENALTY SERIES

When, at the end of the extra-time, the result remains even, the teams will have to remain on the rink so that the winner of the match is decided based on the execution, by each team, of one or more "series" of penalties - *as many as necessary* -taking into account the procedures referred to in the following points.

2.1 FIRST SERIES: FIVE PENALTY SHOTS FOR EACH TEAM

- 2.1.1 In the execution of the penalties, each of the teams may use the players and/or the goalkeepers who are registered in the Official Minutes of the Match, with the exception of the players who were excluded from the match, either by red card or those who - *in the end of the extra-time* - had not yet completed the time of their temporary suspension.
- 2.1.2 Each team must execute, alternately and using different players, the five (5) penalties of this first series. However, each team can use a single goalkeeper to try to defend all penalties.
- 2.1.3 If any of the teams plays with less than five (5)players qualified for the execution of the penalties, it will have to do so on a rotating basis, with the players and or the goalkeepers available for that purpose, indicating to the Auxiliary Referee which will have to repeat the execution, after all the available players have performed one execution.
- 2.1.4 If before the conclusion of this "series", one of the teams no longer has the possibility of scoring more goals than the opposing team, the Main Referees must finish the match and declare as winner the team that had scored more goals.
- 2.1.5 When this first "series" ends with the two teams tied in goals, the winner of the match will have to be decided as established in the next point.

2.2 ADDITIONAL SERIES (S): SUCCESSIVE SERIE(S) OF A PENALTY FOR EACH TEAM

- 2.2.1 Each team must, alternatively, execute a penalty, until one of the teams scores one goal and the other team does not. The team that scores the goal is immediately considered the winner.
 - 2.2.2 In this series of a single penalty, a single player can execute all the penalties of his team. Similarly, each team may use a single goalkeeper to attempt to defend all the penalties.
- 2.3 During the execution of the series of direct free hits to untie a match (*points 3 and 4 of this Article*) the validation of the goals is a responsibility of the MAIN REFEREES, and it is not necessary to ensure the resumption of the match with the execution of any centre pass.

3. PROCEDURES OF THE REFEREES DURING THE TIE-BREAKER OF THE MATCH

- 3.1 The Main Referees will toss a coin on the rink, in the presence of both team captains, to determine:
 - 3.1.1 Which is the goal cage to be used for the execution of the penalty shots; and
 - 3.1.2 Which is the team that starts the execution of the penalties.
- 3.2 Before the start of the penalty shoot-out, the AUXILIARY REFEREE must collect - *from the Coach of each of the teams*- the numbers of the players who will be in charge of the execution of the first series of penalties, according to the order that was indicated.



- 3.2.1 The AUXILIARY REFEREE will have to be placed in the most central position of the half-rink line, being he who indicates, alternately and according to the order determined in the ~~draw~~ draw, which is the player of each team that is in charge of executing each penalty.
- 3.2.2 All players of each team qualified to participate in the penalty shoot-out must be properly equipped (*including the protection mask in the case of goalkeepers*), all placed together on each side of the rink, sideways to the AUXILIARY REFEREE.
- 3.2.3 When begins the execution of a penalty in favour of his team, the designated goalkeeper for defending the following penalty will have to be placed in one of the corners of the fence that is behind the goal cage where all the penalties must be executed.
- 3.3 When the execution of each of the penalties in question occurs, the position and functions of each of the MAIN REFEREES is as follows:
- 3.3.1 One of the Referees must be placed as established in paragraph 9.4 of Article 35 of these Rules and she/he the responsibility to indicate the sign to initiate the execution of the penalty, controlling the action of the player and also the defending goalkeeper, considering that:
- a) There is no repetition of the penalty, not being considered a goal, as long as the player does not comply with what is established in paragraph 5 of Article 35 of these Rules;
 - b) The procedures established in paragraph 7.3 of Article 35 of these Rules shall be insured, when the goalkeeper commits an irregularity in the defence of the penalty.
- 3.3.2 The other Referee must be placed on the opposite side of the penalty area, in the prolongation of the goal line, so that the validation of the goals that may occur.
- 3.4 If, as a result of the execution of a penalty, the ball enters the goal, after having touched the bottom fence, behind the goal cage and then also the goalkeeper, **the goal in question cannot be validated.**
- 3.5 If, as a result of the execution of a penalty, the ball enters the goal, after having touched the posts and then also the goalkeeper, **the goal in question has to be validated.**
- 3.6 For the validation of any goal scored in a penalty shootout in order to untie the game, it is not necessary to ensure the resumption of the match with the execution of an initial centre pass
- 4. PREVENTIVE TIE-BREAKER OF THE MATCH - IN CASE OF AN EVENTUAL QUALIFYING TIE**
Safeguarding the provisions of paragraph 5.7 of this Article, when a match ends tied - *at any stage of the international competitions whose classification is obtained by the attributed points* -the teams will have to remain on the rink in order to participate in a preventive "tie-breaker", with the execution of one or more "series" of direct free hits - *as many as necessary* -taking into account what is established in the following paragraphs.
- 4.1 FIRST SERIES: THREE DIRECT FREE HITS IN CHARGE OF EACH TEAM**
- 4.1.1 In the execution of direct shots, each of the teams can use the players that are registered in the Official Minutes of the Match, **with the exception of the following**:
- a) the goalkeepers; and
 - b) the players who were excluded from the match, either by red card, are those who - *at the end of the extension* - had not yet completed the time of their temporary suspension.
- 4.1.2 Each team must execute, alternately and using different players, the three (3)direct free hits of this first series. However, each team can use a single goalkeeper to try to defend all the direct free hits.
- 4.1.3 When- *before the conclusion of this "series"* -one of the teams no longer has the possibility of scoring more goals than the opposing team, the Main Referees must finish the match and declare as winner the team that had scored the more goals.
- 4.1.4 When this first series ends with the two teams tied in goals, the winner of the match will have to be decided as established in the next point.
- 4.2 ADDITIONAL SERIES (S): SUCESSIVE DIRECT FREE HITS FOR EACH TEAM**
- 4.2.1 Each team must execute, alternately, one (1)direct shot, until one of the teams scores a goal and the other does not. The team that scores the goal is immediately considered the winner.
- 4.2.2 In these series of a single direct free hit, a single player can execute all the direct free hits of his team. Similarly, each team can use a single goalkeeper to try to defend all the direct free hits of each one of the series.
- 5. PROCEDURES OF THE REFEREES DURING THE PREVENTIVE TIE-BREAKER OF THE MATCH**
- 5.1 The Main Referees will toss a coin on the rink, in the presence of both team captains, to determine:
- 5.1.1 Which goal cage is to be used for the direct free hits; and.



- 5.1.2 Which team starts the execution of the direct free hits.
- 5.2 Each one of the Main Referees must be placed in accordance with what is established in paragraph 3.3 of this article and be prepared to ensure different tasks in the specific control of the execution of the direct free hits, in particular those executed with the ball transport.
 - 5.2.1 One of the Referees will sign that the execution of the direct free hit can be initiated, controlling the compliance with the five (5)seconds that are allowed to that.
 - 5.2.2 If it is the case, once starts the transport of the ball for the execution of the direct free hit, the other Referee will control if the conclusion of the same is made in five (5)seconds that are allowed to shoot the opponent goal cage.
- 5.3 Regarding the control of the execution of the direct free hits for a tie break of a match, the procedures to be assured by the Referees must consider:
 - 5.3.1 The provisions of paragraphs 3.2 and 3.3 from this Article, considering the necessary adaptations
 - 5.3.2 The provisions of paragraph 4 of Article 35 from these Rules, with respect to the "general rules of execution of direct free hits."
 - 5.3.3 The provisions of paragraph 7.3 of Article 35 from these Rules, in what respects the "general rules regarding the goalkeeper during the defence of a direct free hit or a penalty"
- 5.4 Regarding the execution of the direct free hits in question, the Referees will have to ensure that:
 - 5.4.1 The executing player may opt- *in accordance with the provisions of paragraph 4.4 of Article 35 from these Rules* -for one of the following forms of execution:
 - a) To make a direct shot that is aimed at the opponent's goal cage; or
 - b) To carry the ball, trying to dribble the Goalkeeper and/or, besides that, making a shot or a deflection of the ball towards the opponent's goal cage.
 - 5.4.2 The executing player may have a maximum of five (5) seconds, either to start the execution of the direct shot, that is - *when he chooses to transport the ball* -to make a shot or deflection of the ball for the opponent's goal cage.
 - 5.4.3 As long as the five (5) seconds are not exhausted, the direct free hit is considered finished, when the executing player makes a shot and the ball is stopped by the goalkeeper.
 - 5.4.4 When the performing player does not comply with the time(s) established in paragraph 5.4.2 of this Article, there is no repetition of the direct free and a goal will not be considered.
 - 5.4.5 If, as a result of the execution of a direct free hit, the ball enters the goal, after having touched the bottom fence, behind the goal cage and then also the goalkeeper, **the goal in question cannot be validated.**
 - 5.4.6 If, as a result of the execution of a direct free hit, the ball enters the goal, after having touched the posts and then also the goalkeeper, **the goal in question has to be validated.**
- 5.5 For the validation of any goal scored in a direct free to insure the preventive untie of the game, it is not necessary to ensure the resumption of the match with the execution of an initial centre pass.
- 5.6 In addition, it is important to show that the result obtained with this preventive tiebreaker does not introduce any change in the result obtained at the end of the normal time of the match, nor is there any alteration of the points attributed to each team(*which maintains the attribution of 1 point*), in accordance with what is established in paragraph 1.2 of Article 4 from these Rules.
- 5.7 **When the preventive tie-break of a match is not necessary**, the entity that has the jurisdiction of the competition will provide the competent information, either to the Main Referees, or to the Delegates of the teams in question.

ARTICLE 4 - POINT SYSTEM, CLASSIFICATION AND TIE-BREAKER CRITERIA

- 1. In events, tournaments and competitions where the point system is used, points will be allocated as follows:
 - 1.1 GAME WON Three(3) points
 - 1.2 TIE One(1) point
 - 1.3 GAME LOST Zero(0)points
 - 1.4 FORFEIT/NO SHOW..... Zero (0)points



2. In events, tournaments and competitions where the point system is used, the final placement is decided, in decreasing order, by the sum of points obtained by each of the teams.
3. **POINT TIE BETWEEN TWO TEAMS - TIE BREAKER CRITERIA TO BE USED**
 In case of occurrence - *at the end of any phase of the same event or competition* - a point tie between two (2) teams, the following tiebreaker criteria will be used, taking only into consideration the results obtained in the same phase of the competition.
 - 3.1 **In a first step, only the games played between the two teams concerned will be considered** and the best ranked team will be the one that obtained the **highest number of points**.
 - 3.2 **If the competition was played in two rounds and the tie remains**, the best ranked team will be the one team that obtained the **largest difference between goals scored and goals suffered**.
 - 3.3 **If the tie remains** and in a second step, it must be considered **all the games played during the entire phase of the event** and the best team will be:
 - 3.3.1 The team that obtained the **largest difference between goals scored and goals suffered**
 - 3.3.2 **If the tie remains**, the best team will be the one that have the **highest overall goal ratio**, resulting from the division of the total goals scored by the total of goals conceded,
 - 3.4 Finally, if the tie still remains, the best team will be the one that *-as established in the paragraph 4 of Article 3 of these Rules* - was the winner of the preventive tie-breaker of the match disputed between the two teams in question.
4. **POINT TIE BETWEEN THREE OR MORE TEAMS - TIE BREAKER CRITERIA TO BE USED**
 - 4.1 When, at the end of any phase of an event or competition, three (3) or more teams have an equal number of points, will be followed the same procedures that are established in paragraphs 2 and 3 of this Article.
 - 4.2 If the classification tie persists, it must be organised - *during the early morning of the first day of the following phase of the competition* - a new series of direct free hits - *as established in paragraphs 4 and 5 of Article 3 of these Rules* - between all the teams involved, considering the confrontations that are established in the following paragraphs.
 - 4.2.1 **HYPOTHESE 1- THREE TEAMS TIED**
 (*Teams defined by a draw to take place before the beginning of the series*)
 - **1st Series:** Team A vs Team B
 - **2nd Series:** Team C vs Team winner of 1st. series
 - 4.2.2 **HYPOTHESE 2 - FOUR TEAMS TIED**
 (*Teams defined by a draw to take place before the beginning of the series*)
 - **1st Series:** Team A vs Team B
 - **2nd Series:** Team C vs Team D
 - **3rd Series:** Team winner of 1st. series vs Team winner of 2nd. series

ARTICLE 5 - NO-SHOW AND ABANDONMENT OF THE MATCH

1. In relation to the official starting time of the match, any of the teams has a margin of fifteen (15) minutes to appear on the rink in conditions to dispute the match.
 - 1.1 When *-after the elapsed of the margin established in the previous paragraph 1* - a team is not on the rink - *or when it is on the rink but not with the minimum number of players required to start the game* - the MAIN REFEREES must consider the "no show" of the referred team, ensuring the following procedures immediately:
 - 1.1.1 To ensure the identification of the players of the team that is in conditions to start playing and confirm the presence of the minimum number of players required.
 - 1.1.2 To perform the salute to the public, and immediately afterwards whistle the end of the match.
 - 1.2 On the official Match Report, the Referees must register, with the necessary detail, the circumstances that led to their decision to assign "no-show" to the team concerned.
2. **In relation to the interval period of a match**, each one of the teams has an additional margin of five (5) minutes to appear on the rink in conditions to continue in the match.
 - 2.1 When *- after the margin established previously has been exhausted* - one team is not on the rink - *or, even if on the rink, does not present the minimum number of players necessary to start the game* - the MAIN REFEREES shall to consider the match as concluded, by abandonment of the team in question.



2.2 On the official Match Report, the Referees must register, with the necessary detail, the circumstances that led to their decision to assign "abandonment of the match" to the team concerned.

3. NO SHOW

The team assigned "no show" is considered defeated by the score of ten goals suffered and zero goals scored (10 - 0)

4. ABANDONMENT OF THE MATCH

The team to which the "abandonment of a match" is recorded will be eliminated from the competition or event in question, which will be formalized by the competent organizing authority (WORLD SKATE-RHTC, CONTINENTAL CONFEDERATION or NATIONAL FEDERATION).

5. When there is a temporary or permanent impossibility of use of the rink, the MAIN REFEREES must grant a margin of fifteen(15)minutes, after which - *and in case of continuation of such impossibility* -they will comply with the following procedures:

5.1 If there is evidence of force majeure – *power failure, water on the rink, slippery rink surface, etc.* –preventing the use of the rink for the scheduled match, the game will be played on another rink. To that effect, the MAIN REFEREES will allow an additional tolerance of ninety(90)minutes, which already includes the time to transfer the teams from one precinct to another.

5.2 If the rink is unfit because of repairable damage, or because another Rink-Hockey game is still going on, the MAIN REFEREES will allow an additional tolerance of thirty(30)minutes for the game to begin.

5.3 If in any of the cases previously mentioned in this Article - *after the additional tolerance time elapsed* -it was not possible to solve the problem, then the MAIN REFEREES will inform the teams that the game will not take place and will report on the official Match Report a detailed information on the facts that led to their decision.

5.4 When the problem is solved, and the game can take place, the MAIN REFEREES will allow twenty (20) minutes for the teams to warm up on the rink. Time will be counted from the moment the rink was made available for the game.

ARTICLE 6 - MATCH PRELIMINARY ACTS AND PROCEDURES

1. All members of the Refereeing team, who are assigned to the match, must arrive at the premises where the match will take place with an advance of at least ninety(90)minutes, before the scheduled time for its beginning.

1.1 The members of the Refereeing team must be present in the rink duly equipped, ensuring the compliance with all the established acts and procedures following established, in order to ensure that the match will be started at the scheduled time.

1.2 Before the beginning of warming session inside the rink of the teams and of the Main Referees, the AUXILIARY REFEREE- *or in her/his absence, one of the Main Referees* - must contact the Delegates of each team, insuring:

1.2.1 The collection of the licenses of their representatives to be inscribed in the official "match report", including the identification of the players' shirt numbers.

1.2.2 The information about the equipment colours to be used by the players and goal-keepers of each team, always ensuring - *if necessary* -- any change that must be provided by the "visited team" - *or as such considered(the Team 1)* -when an agreement is not achieved between the teams.

2 HALF-RINK TO BE USED BY EACH TEAM - TEAM THAT EXECUTES THE STROKE THAT STARTS THE GAME

No raffle is allowed for the choice of the half-rink that is occupied by each team and/or for the definition of the team that will be responsible for the centre pass that starts each match, considering what is established in the following points.

2.1 The "visited team" - *or as such considered (the Team 1)*-will always occupy the half-rink located to the right side of the "OFFICIAL TABLE OF THE GAME", either during the first period of the game or the first period of the extra time or during the warm up before the beginning of the match.

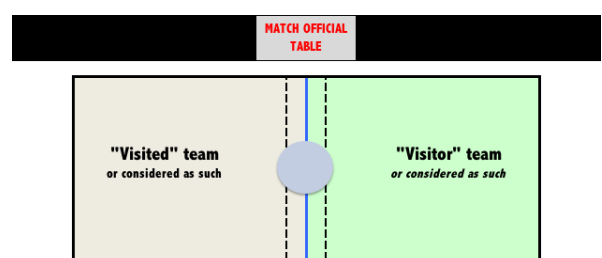
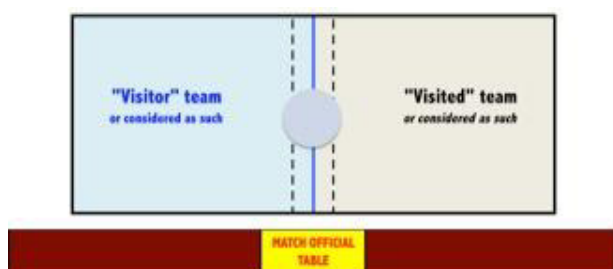

- 2.2 The "visiting" team - *or as such considered (the Team 2)* -is always responsible for the stroke that starts the first period of the game or the first period of the extra time.

3. AVAILABILITY OF THE RINK FOR TRAINING AND WARMING SESSIONS OF TEAMS AND REFEREES

3.1 ADAPTATION TRAINING TO THE RINK SURFACE

The organizing entity of any international competition (of nations or clubs) must guarantee - *on the day before its start and / or, if possible, on the morning of the inaugural day* - the availability of the sports facilities of the event so that the participating teams can carry out - *for a minimum period of thirty (30) minutes* - an adaptation training to the rink surface.

3.2 WARMING-UP SESSIONS OF BOTH TEAMS AND OF THE REFEREES BEFORE ANY MATCH

3.2.1 The organizer entity of the game will have to ensure a prior delimitation - *through placement of "pins"* -of the space reserved for the warming session of the MAIN REFEREES, occupying a central strip that lies in each side of the rink, at about one (1)meter from the central line.

3.2.2 Under normal conditions, the warm-up sessions of both teams must be completed fifteen (15)minutes, at least, before the scheduled time for the beginning of the match.

3.2.3 Safeguarding what is established in the next paragraph, the playing surface has to be available for the referred warming sessions before forty-five (45)minutes, at least, of the time officially scheduled for the beginning of the match.

3.2.4. However, where a delay may occur in the starting time of the match - *motivated, for example, by a delay in a match previously played for the same competition* -the designated MAIN REFEREES will have to previously inform the Delegates and the captains of each team regarding the compliance with the following provisions:

- a) To guarantee a minimum period of twenty (20) minutes for the warm-up of both teams;
- b) To impose that the players of each team do the warm-up with the equipment they will use during the match;
- c) Do not allow any of the teams to return to their locker rooms, after warming up.

4. ENTRY INTO THE RINK OF THE REFEREES AND THE TEAMS

4.1 In normal conditions, the Refereeing team must enter in the rink fifteen(15)minutes before the scheduled time for the beginning of the match, in order to ensure:

4.1.1 The immediate withdrawal of all the players that were warming up;

4.1.2 The verification of the status of both goal cages;

4.1.3 The achievement of all the protocol acts and procedures that are established in paragraph 6 of this Article.

4.2 The players of each team must enter the rink ten (10) minutes before the scheduled time for the beginning of the match.

5. CHOICE OF THE BALL FOR THE MATCH

5.1 The entity that has the jurisdiction of the competition- *WORLD SKATE-RHTC, CONTINENTAL CONFEDERATION or NATIONAL FEDERATION* -has the right, in its discretion, to provide the balls used in all the matches.

5.2 Nevertheless, the "visiting" team- *or considered as such (Team 1)* -is always obliged to ensure the number of balls that are necessary for each match. The "visiting club"- *or considered as such (Team 2)* - also has the right to present and to propose the balls to be used in the match.

5.3 Under normal conditions, the captains of each team must take advantage of the warm-up period to try to reach an agreement regarding the ball to be chosen for the match, which will be given to the MAIN REFEREES after their entry into the field.

5.4 In any case, the choice of the ball for the match is always the responsibility of the MAIN REFEREES, in particular if the two captains do not reach an agreement.



6. **PRESENTATION OF PLAYERS AND REFEREES AND SALUTE TO THE AUTHORITIES AND TO THE PUBLIC**

- 6.1 Immediately before the start of the game, the Refereeing team must ensure their alignment - *together with the players from each team* -in the rink most central location, considering that:
- 6.1.1 It is required the participation of all the players of both teams, which are able to participate in the game, including all the available substitutes.
- 6.1.2 The use - *by the referees and all players* -of the equipment used during the match (*except for goalkeepers, who do not need to place the mask and gloves*), taking into consideration that is not allowed to have the sweater out of the shorts or fallen socks.
- 6.2 In the first place, the “**CHIEF OF THE REFEREEING TEAM**” must ensure a formal salute to the authorities and the public present, which must be carried out - *taking as reference the OFFICIAL TABLE OF THE GAME* -for both sides of the rink except when there is only one tier in the length of the rink.
- 6.3 Subsequently, must be carried out by a speaker the presentation of the names of:
- a) the players and the MAIN COACH of each team;
 - b) the components of the match Refereeing Team
- 6.4 After that, the players of each team greet the Referees and all the representatives of the opposing team.
- 6.5 Finally, the MAIN REFEREES must take the additional steps they deem necessary to ensure that the match is started in accordance with the established official timetable.



CAHAPTER II - CATEGORIES OF PLAYERS - RINK-HOCKEY TEAMS

ARTICLE 7 - CATEGORIES OF PLAYERS, PER GENDER AND AGE

1. According to their gender and age, Rink-Hockey players are classified, at international level, in the following competition categories:

1.1 FEMALE CATEGORIES

Categories - Females	
UNDER-17 Female	13 to 16 years of age
SENIOR Female	= > 14 years of age

1.2 MALE CATEGORIES

Categories - Males	
UNDER-15 Male	12 to 14 years of age
UNDER-17 Male	13 to 16 years of age
UNDER-19 Male	14 to 18 years of age
UNDER-23 Male	14 to 22 years of age
SENIOR Male	= > 14 years of age

2. The Inclusion of players in the different categories is always in function of the year of their birth and the year in which take place the events in which they are registered, as follows:

2.1 FEMALE RINK-HOCKEY PLAYERS

2.1.1 CATEGORY UNDER-17 FEMALE

The player who completed the minimum age of twelve(12)years but has not completed seventeen(17) years by 31 December of the year regarding her registration.

2.1.2 CATEGORY OF SENIOR FEMALE

The player who completed the minimum age of fourteen(14)years by 31 December of the year regarding her registration.

2.2 MALE RINK-HOCKEY PLAYERS

2.2.1 CATEGORY UNDER-15 MALE

The player who completed the minimum age of twelve(12)years but has not completed fifteen(15)years by 31 December of the year regarding his registration.

2.2.2 CATEGORY UNDER-17 MALE

The player who completed the minimum age of thirteen(13)years but has not completed seventeen(17)years by 31 December of the year regarding his registration.

2.2.3 CATEGORY UNDER-19 MALE

The skater who completed the minimum age of fourteen(14)years but has not completed nineteen(19)years by 31 December of the year regarding his registration.

2.2.4 CATEGORY UNDER-23 MALE

The player who completed the minimum age of fourteen(14)years but has not completed twenty-three(23)years by 31 December of the year regarding his registration.

2.2.5 CATEGORY SENIOR MALE

The player who completed the minimum age of fourteen(14)years by 31 December of the year regarding his registration.

3. For Rink-Hockey players of less than twelve (12)years of age, the National Federations can define other categories for specific events and tournaments they wish to organise in different age categories.



ARTICLE 8 - COMPOSITION OF THE RINK-HOCKEY TEAMS

1. In normal conditions, a game of Hockey Skates is played between two teams, each of which must be composed of the following players, duly registered in the official Match Report.
 - 1.1 **Five(5)players**, with the following composition:
 - 1.1.1 **One (1) goal-keeper;**
 - 1.1.2 **Four(4)rink players**
 - 1.2 **One (1) substitute goal-keeper**, which must be available throughout the match, unless an injury or disciplinary sanction (*red card*)prevents the continuation of his presence during all the match.
2. On the other hand, **each of the teams may register in the Rink-Hockey official Match Report, the following representatives:**
 - 2.1 Up to a **total of ten(10)players**, bearing in mind that:
 - 2.1.1 A minimum of two (2)goalkeepers must always be included
 - 2.1.2 It is not allowed- *in any case* -The registration and/or participation of a Coach/Player in any of the international competitions, whether of clubs or of nations
 - 2.1.3 The registration in the official Match Report and the identification of the team players -*including the goalkeepers* -is carried out by means of different numbers -*between one (1) and ninety-nine (99)*, *without being able to use the number zero*-which must be included in the game shirts and, optionally, in the game pants.
 - 2.2 Up to a **total of seven(7)other representatives**, performing the following functions:
 - 2.2.1 **Two (2) OFFICIAL TEAM DELEGATES**
 - 2.2.2 **One (1) MAIN COACH**
 - 2.2.3 **One(1)ASSISTANT COACH (or PHYSICAL TRAINER)**
 - 2.2.4 **One(1)DOCTOR**
 - 2.2.5 **One(1)MASSEUR (or NURSE or PHYSIOTHERAPIST)**
 - 2.2.6 **One(1)MECHANIC (or STEWARD)**
3. Without prejudice of being always ensured the compliance with the established in paragraph 2.1 of this Article, in the international competitions of nations that are disputed in successive days -*under the jurisdiction of WORLD SKATE-RHTC or of any Continental Confederation* - each one of the participating National Federations can ensure **the registration of a total of twelve(12)players, where at least three(3)goalkeepers must be included.**
4. In any case, a rink-hockey match may only be started when each team is represented by:
 - 4.1 **A MINIMUM OF FIVE (5)PLAYERS, with the following composition:**
 - 3.1.1 **Two (2)GOAL-KEEPERS**, one of them as substitute(*which has to comply with the established in paragraph 1.2 of this Article*);
 - 3.1.2 **Three (3) RINK PLAYERS**
 - 4.2 **A MINIMUM OF TWO (2)OTHER REPRESENTATIVES, who obligatorily perform the following functions:**
 - 3.2.1 **One TEAM OFFICIAL DELEGATE;** and
 - 3.2.2 **One MAIN COACH**
 - 4.3 However, any team may introduce its additional representatives who had not started the match, subject to their prior registration in the official Match Report.
5. If, at any time during the match, **a team is reduced to only three(3)players on the rink** - *one (1) goal-keeper and two (2) rink players* -the MAIN REFEREEES must stop the game and call it ended, indicating in the official Match Report the circumstances that determined such a decision, especially detailing:
 - 5.1 If the situation was caused by **abnormal incidents that occurred in the match**, which resulted in injuries, incapacitating the payers who left the rink, **in which situation the organizer may choose to repeat the match, in whole or in part**, having in mind the time already played when the match was definitively suspended.



- 5.2 If the situation has been caused essentially by the disciplinary sanctions decided against the team, in which situation the MAIN REFEREES will have to ensure the entry in the official Match Report that the match was suspended due to a "no show" by the offending team, which will suffer the consequences established in paragraph 3 of Article 5 of these Rules.
- 5.3 If the situation has been caused essentially by the unjustified abandonment of some players, in which situation the MAIN REFEREES will have to ensure the entry in the official Match Report that the match was suspended due to the "abandonment of the game" by the offending team, which will suffer the consequences established in paragraph 4 of Article 5 of these Rules.
6. It is considered a major violation of sports ethics when a team - *having players available on its "reserve bench" and fit to enter the rink* - is in play, with a number of players that is inferior to the number allowed by the Rules of the Game, a situation which will determine the following procedures by the MAIN REFEREES:
 - 6.1 To ensure the immediate interruption of the game, followed by the display of a red card to THE MAIN COACH or - *in her/his absence and in order of preference* - to the ASSISTANT COACH, or to the TEAM DELEGATE or to the PLAYER who performs the functions of captain on the rink.
 - 6.2 To apply the disciplinary sanction of the offending team, which will be sanctioned with the corresponding "period in inferiority", as provided in Article 18 of these Rules.
 - 6.3 After ensuring that the offending team keeps on the rink a total of 4 players (including a goal-keeper), the MAIN REFEREES will order the restart of the match with the execution of a direct free hit against the offending team.

ARTICLE 9 - RESERVE BENCH FOR THE TEAM REPRESENTATIVES

1. The teams will always use the reserve bench in front of their own defensive zone. Therefore, they will switch places at the half-time interval.
 - 1.1 It is mandatory to place a "protection" behind each of "reserve bench" - *in accordance with the figure below* - to improve space safety

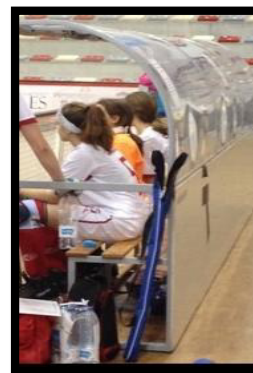

- 1.2 In addition, a barrier/divider shall be placed at each end of the "reserve bench" of each team, so that the space is fully reserved and delimited.
2. Each team has the right to include in its "reserve bench" a total of twelve (12) of its representatives, in accordance with the following composition:
 - 2.1 **FIVE SUBSTITUTE PLAYERS**, including one (1) GOAL-KEEPER, at least



- 2.2 **SEVEN OTHER REPRESENTATIVES**, whose functions are discriminated in paragraph 2.2 of Article 8 of these Rules.



3. When one of the members referred to in paragraph 2.2 of Article 8 of these Rules cannot be registered in the match, it cannot be allowed the presence in the bench of another member who is not registered in the same function.
4. Three(3) of the representatives that integrate the “reserve bench” of each team - *namely, the MAIN COACH* - can stand in the outside fence. However, the other representatives of each team will have to remain seated in their “reserve bench”.
 - 4.1 With the exception of substitute players, **all the other team representatives that are registered in the official MATCH REPORT shall have a credential issued by the organizing entity**, with a current photograph and the indication of their name and function with the team.
 - 4.2 In case of loss of the credential issued by the organizing entity, the team member will not be allowed by the Main Referees to be on the “reserve bench”, unless an express authorisation is issued by the organising entity.
5. Any player or other team representative who has been sanctioned with a red card, being expelled from the match by the MAIN REFEREES, loses the right to integrate the team “reserve bench”.
 - 5.1 The players who have been sanctioned with a blue card, being temporarily suspended from the game, must occupy one of the chairs, placed between the “reserve bench” and the OFFICIAL TABLE OF THE GAME, could not leave the place in any situation (*including the time-outs and/or any other interruption of the match*).
 - 5.2 When a player or other team representative didn’t follow the orders of the Referees and refuses to leave the “reserve bench” - *after being expelled from the match or for any other reason* - the Main Referees must request the police intervention to ensure that their decisions are met.
6. Whenever any anomaly is found in the “reserve bench” of any team, the AUXILIARY REFEREE should try to SOLVE the situation immediately.
 - 6.1 **If the situation is not serious**, the AUXILIARY REFEREE will wait for the normal interruption of the game for reporting the facts to the MAIN REFEREES, in order they assure the appropriate disciplinary action.
 - 6.2. **If one or more serious disciplinary offenses occur**, the AUXILIARY REFEREE will immediately have to ensure the interruption of the match, reporting the situation to the MAIN REFEREES, who will follow the procedures established in paragraph 2 of Article 28 of these Rules.



CHAPTER III - REFEREEING TEAM AND OFFICIAL TABLE OF THE GAME

ARTICLE 10 -REFEREEING TEAM AND TIME-KEEPING

1. REFEREEING TEAM COMPOSITION - TIME-KEEPING OF THE MATCHES

1.1 In the matches of the International Rink-Hockey competitions, the Refereeing team is constituted by three(3)or four(4) International Referees, whose functions are distributed as follows:

1.1.1 TWO(2)MAINS REFEREES, who are responsible for the direction of the match on the rink. The "CHIEF OF THE REFEREEING TEAM" - *who is designated as "Referee 1"* - is the one who performs the duties of "CHIEF OF THE REFEREEING TEAM", as established in paragraph 4.4 of this Article.

1.1.2 ONE(1)AUXILIARY REFEREE, who is responsible for ensuring:

- a) The disciplinary control of the "reserve bench" of each team and of the players temporarily suspended from the game;
- b) The control of each "time-out" granted to each team and the control of the team fouls that are committed;
- c) The information to the public and to both teams - *either with the electronic system or with an alternative system* - in what concerns:
 - The request of "time-out" by each team, and
 - The number of accumulated team fouls, which will be complemented with a specific "warning" whenever a team is in the eminence of being technically sanctioned if an additional team foul is committed

1.1.3 ONE(1)ASSISTANT REFEREE may integrate the refereeing team, to ensure- *where possible, in accordance with the provisions of paragraph 3 of Article 13 of these Rules*- the monitoring of the electronic equipment that allows the control of the time of possession of the ball by each one of the teams.

1.2 ONE (1) TIMEKEEPER- *which integrates the OFFICIAL TABLE OF THE GAME* -ensures support to the Main Referees for their actions on the rink, in accordance with the functions and responsibilities defined in the paragraph 5 of this Article.

2. NOMINATION OF THE REFEREEING TEAM FOR THE INTERNATIONAL COMPETITIONS

2.1 The nomination of the Refereeing teams for the different international competitions (*of nations and clubs*) is the responsibility of:

2.1.1 WORLD SKATE-RHTC, which has the jurisdiction of world competitions.

2.1.2 The different CONTINENTAL CONFEDERATIONS, regarding to the competitions organized in the geographical area that is under their jurisdiction.

2.2 IN THE WORLD COMPETITIONS, all the matches must be led by Refereeing teams constituted by the "ELITE" REFEREES, whose qualification is officially attributed by WORLD SKATE-RHTC.

2.3 Without prejudice to what is established in the following paragraphs - *as regards the different Continental competitions* - the respective matches will be controlled by the Refereeing teams officially nominated by the organizing Confederation, which must be composed by international referees of their affiliation.

2.3.1 The organizing Continental Confederations may request the collaboration of WORLD SKATE-RHTC to guarantee the appointment of international referees who are affiliated in other Continental Confederations.

2.3.2 However, it is totally forbidden to any CONTINENTAL CONFEDERATION- *without the prior and formal consent of WORLD SKATE-RHTC* -to make invitations for refereeing its competitions to any Referee who is affiliated in another CONTINENTAL CONFEDERATION.

3. DESIGNATION OF THE REFEREEING TEAM IN THE NATIONAL COMPETITIONS

3.1 In the national competitions of the each one of the different countries, the responsibility to ensure the appointment of the Refereeing team of each match it is the sole responsibility of the respective AFFILIATED NATIONAL FEDERATION, in accordance with the procedures that they consider to be the most appropriate and considering the provisions of the following points.

3.2. In the club competitions of the highest level- (*male and/or female senior categories*) - the following conditions are mandatory:



- 3.2.1 All matches must be led by 3 (*three*) Referees officially qualified by the National Federation in question, with 2 (*two*) designated as Main Referees and 1 (*one*) appointed as Assistant Referee.
- 3.2.2 In accordance with the provisions of Article 13 of these Rules, the control and information to the public - *result of the game, the accumulate number of team fouls and the time of playing* - must be carried out by the appropriate electronic system, which must be commanded from the OFFICIAL TABLE OF THE GAME, determining the additional designation of an Assistant Referee.
- 3.3. In the other national club competitions, the matches may be conducted by 1 (*one*) or 2 (*two*) Main Referees, admitting that the functions of Assistant Referee and Timekeeper may be exercised by:
- 3.3.1 Elements officially authorized by the National Federation in question; or in alternative
- 3.3.2 The Auxiliary referee will be proposed by the "visiting" team and the Timekeeper will be proposed by the "visited" team.
- 3.4 Regarding the different NATIONAL COMPETITIONS, all the matches must be directed by Refereeing teams constituted by the AFFILIATED REFEREES of the ORGANIZING FEDERATION, who are in normal activity, safeguarding the established in the following points:
- 3.4.1 The organizing National Federations may request the collaboration of the CONTINENTAL CONFEDERATION of their affiliation, to guarantee the appointment of referees that are affiliated in other National Federations of the same Confederation.
- 3.4.2 However, it is totally forbidden to any NATIONAL FEDERATION - *without the prior and formal consent of the CONTINENTAL CONFEDERATION of affiliation*- to make any invitation for ~~whistling~~ refereeing its competitions to any Referee who is affiliated in another National Federation.
- 4. FUNCTIONS AND RESPONSIBILITIES OF THE REFEREEING TEAM**
- 4.1 All the Rink-Hockey Referees have the duty to comply with and enforce the official Rules of the Game and other regulations coming from the international and national bodies in which they are affiliated, in particular, in what concerns the various provisions, rules, regulations, procedures, interpretations and clarifications regarding his activity in the Rink-Hockey Refereeing.
- 4.2 The coordination between the Referees that are integrating any "Refereeing team" assumes a relevant importance in their performances, requiring - *for an effective control of all the situations of the game* - not only a correct mobility and placement in the rink, but also an adequate distribution of their functions.
- 4.3 MAIN REFEREES - FUNCTIONS AND RESPONSIBILITIES**
- 4.3.1 The MAIN REFEREES are the absolute judges in the playing rink and their decisions - *concerning the match* - must be carried out with effective competence and total responsibility, always guided by their impartiality and by scrupulous compliance of the Laws of the Game and other Regulations in force.
- 4.3.2 The MAIN REFEREES must move on the rink so that they can follow the game closely, having the right to exercise disciplinary actions on the Players or on the other representatives of any team - *either before the start of the game, during the course of the game. same, during the interval or after its end* - acting with the rigour that is needed for the practice of a correct game and free of brutality.
- 4.3.3 When necessary - *with the match inactive* - the MAIN REFEREES should contact the AUXILIARY REFEREE to clarify any matter that may have occurred along with the OFFICIAL TABLE OF THE GAME. In these situations, the presence - *both inside and outside the rink* - of any team player or representative is not allowed, except if previously authorized.
- 4.3.4 The MAIN REFEREES may request the police intervention only when there are serious problems related to the behaviour of the public or when a player or another representative of any team - *who is located in the respective "reserve bench" or in the zone of the OFFICIAL TABLE OF THE GAME* - refuses to comply with the Referees' determinations.
- 4.3.5 In the incidents or cases omitted in the Rules of the Game, the MAIN REFEREES must decide according to their conscience, trying to resolve all the cases, through the actions they deem necessary and evaluating and judging the claims that may occur, always ensuring - *having in mind the provisions established in Article 36 of these Rules*- the correction of possible irregularities and/or serious errors that may be detected during the game, always favouring a rigorous application of the regulations in force, in defence of ethics and of the sport truth.



- 4.3.6 Regarding his intervention in the development of the match, specifically involving any decisions on fouls and violations, **there is no differentiation between the "CHIEF OF THE REFEREEING TEAM" and the other MAIN REFEREE.**

4.4 SPECIFIC DUTIES OF THE "CHIEF OF THE REFEREEING TEAM"

- 4.4.1 Relatively to the Main Referees that are specifically nominated for each match, the "CHIEF OF THE REFEREEING TEAM" is always the one that is indicated as "REFEREE 1", which is specifically responsible for performing the following functions:
- a) To check, before the start of the match, the following specific questions:
 - The conditions of the rink and the system used for the "time keeping";
 - The identification of the players and other representatives of both teams;
 - The information system that can be provided to the public and the teams on the progress of the game (*time keeping, result, time-outs granted, number of team fouls*)
 - Review- *if applicable* - of the electronic equipment that controls the ball possession time of each of the teams.
 - b) To call the team captains to his presence, when it is necessary to choose the match ball
 - c) To verify if all the participants are ready, to whistle for the start or restart of each one of the periods of the match, after verifying if all the participants are ready.
- 4.4.2 When there are doubts about arbitration decisions in the match - *or whenever there are divergences of views* -the "**CHIEF OF THE REFEREEING TEAM**" should consult the other members of the Refereeing team and decide - *with impartiality, rigour and common sense* -any divergence, problem or difficulty that may occur in any game situation, considering:
- a) The correct application of the Rules of the Game and of the Technical Regulation, as well as other regulations or issues of a regulatory nature;
 - b) The resolution of the incidents that may occur, assuming the corrective actions that he considers necessary, after evaluating the claims with which it can be confronted.
- 4.4.3 To prepare and sign - *when necessary* -the Refereeing "**CONFIDENTIAL REPORT**" and confirm the correct preparation of the "**OFFICIAL REPORT OF THE MATCH**" and other official documents - *confirming if they are duly completed and signed by the two Referees and any other intervening parties* - after providing the introduction of the rectifications that he considered necessary.
- 4.4.4 To deliver - *or ensure delivery within the deadlines and regulatory conditions* -to the international or national organizing authority of the competition of all the documents referred in the previous paragraph.

4.5 AUXILIARY REFEREE - FUNCTIONS AND RESPONSIBILITIES

- 4.5.1 The control of the OFFICIAL TABLE OF THE GAME is always the responsibility of an AUXILIARY REFEREE, duly equipped, whose functions and responsibilities are, in particular:
- a) To ensure a rigorous and effective control of the disciplinary behaviour of the representatives of each team - *namely those that are in their "reserve benches"* -informing the MAIN REFEREES about possible infractions occurring off the rink.
 - b) To help the MAIN REFEREES in the detection and correction of irregularities and/or serious errors committed during the game.
 - c) To ensure that the relevant information regarding the development of the match is provided to the public and the participating teams, in particular:
 - The current result of the match;
 - The time of the match that still needs to be met
 - Cumulative number of team fouls already committed by each of them.
 - Time-out requested by each team.
 - d) To make all the necessary notes and records to effectively control the incidents of the match, in order to ensure support for the MAIN REFEREES in the preparation of the Minutes of the game.
- 4.5.2 The **AUXILIARY REFEREE** has in addition to control and support the action of the **TIMEKEEPER**, rectifying eventual failures and informing the **MAIN REFEREES**- *if that is the case and taking advantage of an interruption of the game* - on any problem and/or eventual disciplinary infraction that is imputable to the Timekeeper



5. TIME-KEEPER - FUNCTIONS AND RESPONSIBILITIES

- 5.1 In the official rink-hockey competitions recognized by WORLD SKATE-RHTC it is recommended the use of and luminous electronic panel- *controlled from the OFFICIAL TABLE OF THE GAME* -that allows the performing of the decreasing record of the time that remains to be met for the end of each period of the match.
- 5.1.1 The clock is stopped every time the match is stopped by the Main Referees, thus allowing the public and the team representatives to have a correct and transparent information.
- 5.1.2 Nevertheless, manual chronometers can also be used for the timing control of the matches, an option that obliges the time-keeper in the OFFICIAL TABLE OF THE GAME to have, in a very visible way, an information system to the public about the number of minutes remaining for the end of each period of the game.
- 5.2 To the Timekeeper competes, specifically and in particular, to carry out:
- 5.2.1 The control of the time of each period of the match, considering that:
- a) The time has to start counting from the whistle of the Referees at the start of the game
 - b) When the end of each period of the match is reached, a warning signal must be made to indicate to the referees that they must whistle to give the game over.
 - c) In all situations, each period of the match begins and ends with the whistle of the MAIN REFEREES, being the sound signal of the time-keeper merely informative.
- 5.2.2 The control of the duration of the resting interval, making a warning signal when there is only one (1) minute remaining.
- 5.2.3 The control of all the time-outs granted in each period of the match, providing the public with the indication of the team to which they are attributed
- 5.2.4 The control of the fulfilment of all the disciplinary sanctions, either in respect to players (*suspensions of the game, after a blue card*) or in respect to the respective teams (*when obliged to play any "period in inferiority"*)

ARTICLE 11 -ABSENCE OR SUBSTITUTION OF THE APPOINTED REFEREES - PROCEDURES

1. ABSENCE OF THE DESIGNATED OFFICIAL REFEREEING TEAM - PROCEDURES

A match must always take place, even if there is the absence of the Refereeing team that had been officially appointed. Consequently, if its absence is verified - *and there is no information on the reasons for it* - a tolerance of thirty (30) minutes will have to be granted, after which the procedures established in the following points will be adopted.

- 1.1 In the absence of the two designated MAIN REFEREES, the designated AUXILIARY REFEREE will be in charge of the refereeing of the match.
- 1.2 In the absence of one of the designated MAIN REFEREES, the match will be led by:
- 1.2.1 The other appointed MAIN REFEREE, who will act as the "CHIEF OF THE REFEREEING TEAM"; and";
 - 1.2.2 The appointed AUXILIARY REFEREE.
 - 1.2.3 Consequently, if the arrival of one (*or two*) of the absent Main Referees occurs after the start of the match, he (*they*) cannot participate in the match.
- 1.3 If all the Refereeing team is absent, the official Delegates of each team must agree on the appointment of a person as the Referee of the match, in accordance with the following procedures and criteria:
- 1.3.1 If one or more active referees are present in the rink, the one elected for the refereeing of the match must be the most qualified one, in terms of category or, in case of equality, by the oldest referee.
 - 1.3.2 If there are no active referees in the attendance, but one or more Referees already retired are present, the one elected an unofficial Referee who has the consent of the official Delegates of both teams.
 - 1.3.3 In the absence of an active or of a retired Referee, it can be elected the match shall be called by an unofficial Referee who has the consent of the delegates of both teams.
 - 1.3.4 If there is no agreement between the official delegates of each team, the match will have to be directed, in each period, by a coach or a delegate of each team, bearing in mind that the referee appointed by the local club - *or as such considered (Team 1)*-will be the Referee of the match during its first period (*and the same criteria will apply if an extra time is necessary*).



2. REPLACEMENT OF ONE OF THE MAIN REFEREES, IN CASE OF INJURY OR INCAPACITY

Safeguarding the established in paragraph 2.3 of this Article, when for reasons of injury or physical incapacity one of the MAIN REFEREES must leave the match, the following procedures must be followed:

- 2.1 When the match was being led by two MAIN REFEREES, the substitution is not affected, and the match will continue to be directed only by the other MAIN REFEREE.
- 2.2 When the party was being led by a single MAIN REFEREE, its substitution will be cast by the AUXILIARY REFEREE or, if this one is also absent, the substitution must be decided by agreement between the official Delegates of each team, in accordance with the procedures established in paragraph 1.3 of this Article.
- 2.3 When one (or two) referees - who have started a match - decide to interrupt and terminate it after suffering an attack or for any other reason related to his (their) safety, no other Referee may substitute him (them) to give continuity to that match.

3. NO SHOW OF ONE OF THE TEAMS AND ABSENCE OF THE REFEREEING TEAM

When occurs that one of the teams is absent and, at same time, are also absent all the designated members of the Refereeing team, the official Delegate of the team that is present must provide the following procedures and diligences:

- 4.1 Try to find- *among the attendance* - a Referee in activity or one who is already retired (*in order of preference*)
- 4.2 If this is not possible, the same delegate should request the intervention of one of the following elements (*also in order of preference*):
 - a) A leading member of the entity having jurisdiction of the competition (*WORLD SKATE-RHTC or Continental Confederation*);
 - b) A leading member of the National Federation of affiliation of the club in question;
 - c) Two suitable persons who are in attendance, preferably if they have any link to rink-hockey
- 4.3 The "chosen" element will have to be responsible for the preparation and signing of the following documents, which will be presented by the official delegate of the team that is present:
 - a) The formulary related with the "TEAM LICENCES CONTROL" - *together with the licenses or identification documents of the players and other representatives who are present* - **that serves as certification and identification of the relationship presented in the official "MATCH REPORT"**;
 - b) **The official "MATCH REPORT"** where - in addition to the "TEAM LICENCES CONTROL" - must refer all the facts that occurred during the match that was not held,
- 4.4 The two previously referred documents must be sent by the club that was present to the entity responsible for the organization of the competition (*WORLD SKATE-RHTC or CONTINENTAL CONFEDERATION*).

ARTICLE 12 - REFEREEING PERFORMANCE EVALUATION - THE TECHNICAL DELEGATES

1. With the aim of encouraging the improvement of quality standards, in technical terms, of the international Rink-Hockey Referees, it is the responsibility of the **WS-RHTC**- *and also of all the Rink Hockey Technical Committees of all the Continental Confederations* -to ensure:
 - 1.1 The elaboration and setting up of an observation and evaluation system of the International Referees, guaranteeing the promotion of those who prove to be the best and most qualified to exercise these functions.
 - 1.2 The recruitment, training, selection and nomination of Technical Delegates to carry out the regular observation and evaluation of the International Referees' performance, namely at the major international events.
 - 1.3 The development and dissemination of a "Manual of Performance" of the Rink-Hockey's Referees, systematizing processes and procedures and promoting the interpretation of the Rules of the Game, so that they can be applied uniformly.
2. Under the functional coordination of WS-RHTC, the main responsibilities of the Technical Delegates are the following:
 - 2.1 To observe and to evaluate the actions and performance of the International Rink-Hockey Referees, issuing impartial and objective judgments of the technical capacities of the Referees they observe.
 - 2.2 To draft an "evaluation technical report" for every observation carried out, describing, with the necessary accuracy and detail, every anomaly, error and/or infraction possibly committed by the Referees under observation.



- 2.3 To cooperate with the respective Rink Hockey Committee in all the training initiatives related with the international Rink-Hockey Referees.
3. The Technical Delegate is not authorized to occupy any place in the OFFICIAL TABLE OF THE GAME, having to observe the match in the stands or in a place reserved by the organizing entity.

ARTICLE 13 - MATCH CONTROL THROUGH AUXILIARY ELECTRONIC EQUIPMENT

Each National Federation, club or any other entity which is responsible for the organization of rink-hockey international matches, for Nations or clubs, is obliged to use the appropriate electronic equipment to ensure the information established below.

1. INFORMATION RELATING TO ANY "TIME-OUT" REQUESTS

1.1 When a team requests a "time-out", the AUXILIARY REFEREE responsible for its control in the OFFICIAL TABLE OF THE GAME - *after confirming that the team in question can use such right* - must immediately ensure one of the following procedures:

1.1.1 If there is adequate electronic equipment ("*electronic towers*"), the green backlight is activated in the "tower" which is placed on the side of the OFFICIAL TABLE OF THE GAME which is closest located to the "reserve bench" of the team that requested the "time-out"

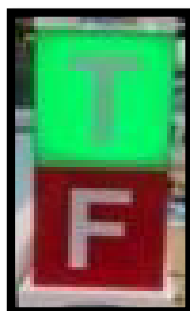

1.1.2 In the event that there is no electronic equipment, a flag or other object that serves to indicate the request of the "time-out" in question will be placed on the same edge of the table. In this situation, the AUXILIARY REFEREE will verbally inform the other team that a "time-out" was requested by the other team

1.2 Without prejudice to this information, the AUXILIARY REFEREE will sound a whistle to guarantee the assignment of the "time-out", cancelling the signalling after the "time-out" is granted.

2. INFORMATION ABOUT THE EMINENCE OF DIRECT FREE REGARDING TEAM FOULS ACCUMULATION

2.1 When a team reaches an accumulated number of team fouls (9, 14, 19, 24, etc.) which indicates the eminence of being sanctioned with a direct free hit, the AUXILIARY REFEREE who is responsible for its control in the OFFICIAL TABLE OF THE GAME must ensure one of the following procedures immediately:

2.1.1 If there is adequate electronic equipment ("*electronic towers*"), the red backlight is activated in the "tower" placed on the side of the OFFICIAL TABLE OF THE GAME closest to the "reserve bench" of the team in question.

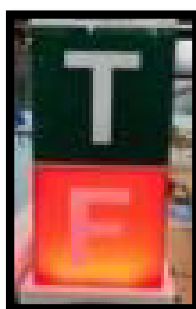

2.1.2 In the event that there is no electronic equipment, a "flag"- or other object that serves to signal the eminence of a direct free hit - must be placed on the side of the OFFICIAL TABLE OF THE GAME closest to the "reserve bench" of the team in question.

2.2 Without prejudice to this information, the AUXILIARY REFEREE will sound a whistle to guarantee the attribution of the corresponding direct free hit, cancelling the signalling after the "direct free hit" is granted.



3. CONTROL OF THE BALL POSSESSION TIME

3.1 In the **OFFICIAL TABLE OF THE GAME**, the equipment console must be in place to ensure the control of the ball possession time of each team, which is 45 (*forty-five*) seconds maximum.



3.1.1 Each one of the information panels of the ball possession time has to be placed behind the fence and the protection networks - *at a distance between 1 and 2 meters* - and they must be placed in the area that is located behind each one of the goal-cages.



3.1.2 The base for the placement of the luminous panels must be placed at a minimum height of 1,40 meters

3.2 These equipment's are of compulsory use in international competitions - *for Nations and clubs*-that are organized by WS-RHTC or by the different Continental Confederations their operation will have to be assured by an "ASSISTANT REFEREE" designated for each match.

3.2.1 Regarding the competitions organized by the different National Federations, it is recommended that they also ensure the use of these equipment's, in particular in the competitions of the all the Senior categories (*Men and Women*).

3.3.2 However, it will be the responsibility of the different Continental Confederations to decide if the use of these equipment's is mandatory in the competitions that will be organized by their affiliated National Federations.

3.3 The horn of the control equipment that signals the end of the ball possession time is merely indicative, always being the whistle of the Main Referees that is valid to insure the interruption of the match and to indicate the execution of the corresponding indirect free hit, in favour of the other team.

3.4 In normal situations, the Main Referees should not interfere or make any signal to the "ASSISTANT REFEREE" who is operating the equipment for the control of the ball possession by each team.

3.5 However, the Main Referees will have to ensure:

3.5.1 "Warning signs" - *raising the arms well above their heads* - when the team that is in possession of the ball has only five (5) additional seconds to shoot at the opponent's goal.

3.5.2 "Counting signs"- *to be made with one of the arms* -when a team takes the possession of the ball in its defensive zone, in order to count the seconds of ball possession inside that zone.

3.5.3 The interruption of the game with a whistle, to signal indirect fault against the team that exceeds the time for the possession of the ball, either in its defensive zone or without shooting the ball against the opponent's cage.



ARTICLE 14 - OFFICIAL TABLE OF THE GAME - COMPOSITION

1. In the rink-hockey matches, it must be reserved - *on the outside of the rink, in a central position and closest to it to allow the best possible visibility* - a space for the placement of the OFFICIAL TABLE OF GAME, totally isolated from the public and having the necessary amenities.

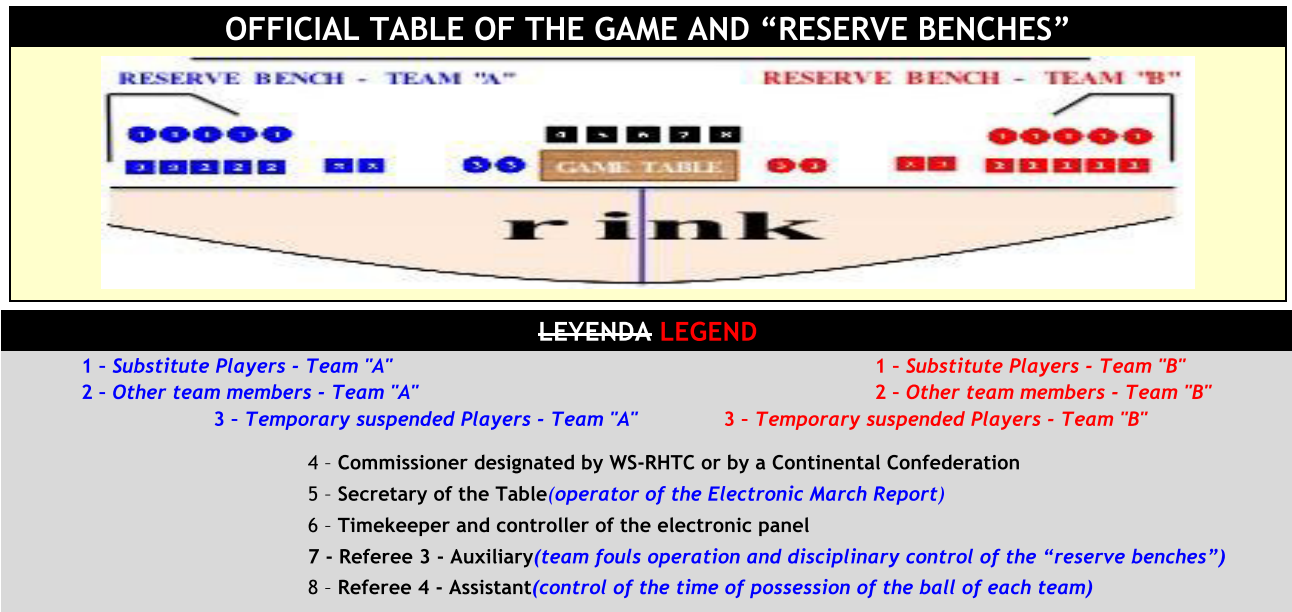

2. The OFFICIAL TABLE OF GAME has the following composition:
 - 2.1 By nomination of the National Federation and/or the entity responsible for the precinct of the match, a **TIMEKEEPER** (*and operator of the electronic panel, if it is the case*).
 - 2.2 By nomination of the supervising entity of the event (*WS-RHTC or Continental Confederation*):
 - 2.2.1 A **COMMISSIONER**, who is responsible for directing the OFFICIAL TABLE OF THE GAME;
 - 2.2.2 A **SECRETARY**, who ensures the management of the official match report, either by electronic means or manually.
 - 2.2.3 An **AUXILIARY REFEREE**, who controls the team fouls and the discipline in the teams' reserve benches, helping and/or clarifying, when necessary and possible, any incident occurred in the match.
 - 2.2.4 An **ASSISTANT REFEREE**, who ensures the control of the possession of the ball by each team, when the appropriate electronic system is available on the rink.
3. In each match precinct of the international competitions, the entity responsible for the organization of the event must provide that the OFFICIAL TABLE OF THE GAME is equipped with the following equipment and materials:
 - 3.1 Five chairs next to the OFFICIAL TABLE OF THE GAME
 - 3.2 Two chairs on each side of the OFFICIAL TABLE OF THE GAME (*4 chairs in total*) for use, when applicable, of the players of each team that were temporarily suspended from the match.
 - 3.3 A portable computer and a printer with digitalization, including the replacement of all the materials that are necessary for its operation (*paper, ink, toner*)
 - 3.4 Two (2) manual informative indicators (*one for each team*) about the accumulative team fouls that are being committed during the match.
 - 3.5 The electronic control equipment mentioned in **Article 13** of these Rules, that is:
 - 3.5.1 Two (2) "Towers" - *one relative to each team* - in order to give information about:
 - a) a "time-out" that will have to be granted in the next interruption of the match; and
 - b) a new "team fault" will imply a direct free hit against the offender's team.
 - 3.5.2 Two (2) information panels, allowing the "control" of each team in what concerns the time of ball possession.
4. Each National Federation is responsible for the definition - *in their rink-hockey national competitions* - what should be the composition of the OFFICIAL TABLE OF THE GAME, taking in attention that is compulsory - *at least* - the designation of:
 - 4.1 A **TIMEKEEPER**; and
 - 4.2 An **AUXILIARY REFEREE**



CHAPTER IV - PLAYING ZONES, PASSIVE PLAY AND ANTI-PLAY

ARTICLE 15 - PLAYING ZONES --DEFENITION OF PASSIVE PLAY AND OF ANTI-PLAY

1. ZONES OF PLAY

The line that divides the rink in two halves delimitates, for each team, two "zones" of play - a "DEFENSIVE ZONE" and an "ATTACKING ZONE" - in which the time allowed for ball possession differs, as specified hereafter.

1.1 DEFENSIVE ZONE - TIME AND CONTROL OF BALL POSSESSION

- 1.1.1 When a team gains possession of the ball in its defensive zone, it is allowed ten (10)seconds to start offensive action, driving the ball into its attacking zone, crossing the line dividing the rink.
- 1.1.2 After a first situation of attack - *except for paragraph 2.1.2 of this Article*- the ball may be returned to the defensive zone of the attacking team, but the team is then allowed only five (5)seconds to drive the ball again it its attacking zone.
- 1.1.3 In any of the situations mentioned in the two previous points, the MAIN REFEREES should only consider infraction if the ball is maintained with the team that has the ball after the time established for its possession in the defensive zone has been exhausted.
- 1.1.4 The offending team will be sanctioned with an indirect free hit- *which will be drawn in accordance with paragraph 3.2 of this Article* -provided that:
- It is exceeded - *according to the provisions of paragraphs 1.1.1 and 1.1.2 of this Article*- the time of possession of the ball in its defensive zone; or
 - the player who has the possession of the ball make an option of placing it in the upper part of one goal cage or immobilizing it in any of the outer networks that delimit it.

1.2 ATTACKING ZONE - TIME AND CONTROL OF BALL POSSESSION

- 1.2.1 When organising their attacking actions, the teams must try to shoot at their opponent's goal cage, aiming to score a goal. The conclusion of these actions should occur within a reasonable period that cannot exceed forty-five(45)seconds of ball possession in each attacking action.
- 1.2.2 The counting of the ball possession time during the team's attacking actions will be done by the adequate electronic equipment or- *in its absence* -by the MAIN REFEREES taking in consideration the counting "rules" established hereunder.
- 1.2.3 The counting of ball possession time is always interrupted when:
- the team that had its possession benefits from a direct free hit or a penalty;
 - the ball touched one post of the opponent goal-cage posts or was touched by its Goal-keeper;
 - The ball is recovered by the opposing team, returning later to the possession of the team that initially had it.
 - The match is restarted by the Referees with a "face-off"
- 1.2.4 The counting of ball possession time cannot be interrupted when one of the following situations occurs:
- The team having possession of the ball in the attacking zone chooses to return it to its defensive zone;
 - The possession of the ball returns to the team that had it, after a shot to the opponent goal-cage, without the ball having touched its posts or the defending Goalkeeper
 - The ball was touched by an opponent player, without recovery, returning almost immediately to the team that previously have its possession.
 - A technical foul is signed and sanctioned with an indirect free shot, in favour of the team that was in possession of the ball.
- 1.2.5 In addition to the one established in the previous point, the counting of the ball possession time is also not interrupted when:
- the ball is intercepted or touched by an opponent and goes off the rink
 - the ball is intercepted or touched by an opponent and goes up to a height higher than 1,50 meters

In either of these two situations, the Main Referees will restart the match by calling for the execution of a free indirect favourable to the team that, before the interception, has the possession of the ball, without interrupting the counting of the corresponding time.



2. DEFINITION OF PASSIVE PLAY

- 2.1 It is considered that a team incurs in the practice of passive play when - *after having started attacking action* -one of the following situations occurs:
- 2.1.1 When one or more of the team's players are clearly in a situation of scoring but avoid materialising the goal.
- 2.1.2 When the team keeps possession of the ball - *for a maximum period of forty-five (45) seconds* - making no recognisable attempt to shoot at the opponent's goal cage, as established in paragraph 1.2.1 of this Article.
- 2.2 When a team incurs in the practice of passive play, the Main Referees cannot sanction this offence immediately, as they are obliged to ensure the procedures set out in.
- 2.3 In compliance with what is established in paragraphs 1.1. and 1.2 of this Article, the MAIN REFEREES cannot admit, in any case, any exception to the sanction of passive play, even when practiced by a team that plays in "inferiority".

3. PROCEDURES TO BE TAKEN BY THE MAIN REFEREES IN CASE OF PASSIVE PLAY

- 3.1 When a team incurs in the practice of passive play, the Main Referees must- *previously and very clearly* - give a "warning" that play may be interrupted to signal the offence. This "warning" - *that should not exceed forty (40) seconds of ball possession in each attacking action* - must be made as follows:
- 3.1.1 ONE OF THE MAIN REFEREES- *preferably the one who is nearest to the place where the ball is*- must raise both arms well above her/his head to warn the attacking team that, from that moment on, it has only five(5)seconds to conclude its attack by shooting at the opponent's goal cage.
- 3.1.2 When he perceives this "warning", THE OTHER MAIN REFEREE must immediately start - *by means of specific gestures* -the counting of the five(5)seconds allowed for this team to shoot at the opponent's goal cage.
- 3.1.3 IF THE OTHER MAIN REFEREE does not immediately start counting, then the same referee who initiated the "warning" will have also to ensure the referred counting.
- 3.2 Whenever the attacking team does not conclude its attack - *not shooting at the goal cage before the five (5) seconds are over* -the Main Referees will stop the game immediately, sanctioning the offending team with an indirect free hit that shall be taken as followed established:
- 3.2.1 If the ball was in the "defensive zone" and inside the offending team penalty area, an indirect free hit will be executed by the opposing team in any of the top corners of the offending team penalty area.
- 3.2.2 If the ball was behind the goal of the team of the offender, an indirect free hit will be executed by the opposing team in any of the bottom corners of the offending team penalty area.
- 3.2.3 If the ball was in the "defensive zone" and outside of the offending team penalty area, an indirect free hit will be executed by the opposing team in the same place in which the ball was at the time of the interruption of the match.
- 3.2.4 If the ball was in the "attacking zone" of the offending team, the indirect free can be executed allowing the team that benefits from the indirect free in its "defence zone" to put the ball in play, without being necessary to strictly respect the exact place where the fault was committed.

4. DEFINITION OF ANTI-PLAY

The practice of anti-play is a clear violation of the ethical principles of sport.

Anti-play occurs when the team in possession of the ball shows no intention of attacking the opposite goal cage to score a goal, while at the same time the other team assumes a passive attitude, showing no intention of gaining possession of the ball, both renouncing as such to any attempt of scoring a goal.

5. PROCEDURES OF MAIN REFEREES IN CASE OF ANTI-PLAY

When both teams incur in the practice of anti-play, it requires prompt and firm action by the MAIN REFEREES in order to reinstate a healthy spirit of competition. They will act as follows:

- 5.1 The MAIN REFEREES interrupt the game and meet in the centre of the rink with the captains of both teams- *or with their substitutes on the rink* -to warn them that the practice of anti-play should be abandoned immediately. The game will be restarted with a face-off, executed on the same spot as the ball was when interrupted.



- 5.2 If nevertheless the teams do not consider the warning, the MAIN REFEREES will immediately whistle to stop the game again and show to either team captain- *or to their substitutes on the rink* -a blue card- *two (2) minutes suspension for each one* -and the game will be restarted with a face-off at the place where the ball was when play was interrupted.
- 5.3 When this still does not work and both teams persist in anti-play practice, the MAIN REFEREES will immediately whistle to end the match. They will write a detailed report of the facts on the official Match Report.
- 5.4 When the MAIN REFEREES do not take appropriate action to correct the teams' conduct, the International Committee member present at the Official Table will immediately intervene, at the first stoppage in the game, to call the MAIN REFEREES to their presence and demand that they apply the procedures established in the previous paragraphs.

ARTICLE 16- TIME-OUTS

1. In each of the one of the two periods of the normal time of a rink-hockey match, each team can request:
 - 1.1 One (1) time-out" with the duration of one(1)minute.
 - 1.2 One (1) time-out" with the duration of thirty(30)seconds, which can only be granted after having been requested the time-out referred to in paragraph 1.1 of this Article.
 - 1.3 When a team does not request one or both "timeouts" in the first period of the match, they may not add them to the time-outs authorized for the second period of the match.
 - 1.4 In any "extra-time" of a match " no time-outs can be granted to any of the teams, even when they have not been requested during normal playing time.
2. Without prejudice to the established in paragraph 4 of this Article, each time-out must always be requested before the AUXILIARY REFEREE, who is in the OFFICIAL TABLE of the game, either by the MAIN COACH or by one of the official Delegates of the applicant team.
 - 2.1 In this situation, the AUXILIARY REFEREE will immediately assure the following procedures:
 - 2.1.1 The placement of a specific information sign -*electronic "tower", flag or other suitable device* -that must be placed on the top edge of the OFFICIAL TABLE OF THE GAME that is nearest of the "reserve bench" of the team that requested the time-out;
 - 2.1.2 The record in the official match report of each time-out that have been requested by each team, even if the they decided to resign to it, after having already being secured the procedures established in paragraph 2.1.1 of this Article.
 - 2.2 When the first interruption of the game occurs, the AUXILIARY REFEREE will have to notify the MAIN REFEREES - *by means of a beep or sound signal* -that they must not restart the match before it is granted the time-out requested by the team in question.
3. A time-out will only be effective after the MAIN REFEREES confirm - *by a whistle and a specific signal* -their authorization for the corresponding game interruption, considering that - *if there are one or more players injured inside the rink* - the MAIN REFEREES can only order the start of the time-out, after finishing the assistance and/or after the injured players leave the rink.
 - 3.1 Once the "time-out in question has ended, the AUXILIARY REFEREE will issue a new audible warning, to indicate to the MAIN REFEREES that they must restart the match.
 - 3.2 When the team requesting the time-out does not use a part - *or all* -of it, the MAIN REFEREES must ensure the necessary steps to ensure the immediate restart of the match, which must be made by the **whistle** of one of the Referees.
4. During the time-out, the players of each team must meet before his own "reserve bench" and both teams can ensure the substitution of players.
 - 4.1 The MAIN REFEREES will keep the ball in their possession and will be placed in the middle of the rink, so that they can observe and control the players and the other representatives of the "benches" of both teams.
 - 4.2 The restart of the game will have to be assured by the MAIN REFEREES by means of a whistle, except when the restart of the game is made with the execution of a direct free hit or a penalty



CHAPTER V - REFEREEING DISCIPLINARY ACTION

ARTICLE 17 - DISCIPLINARY SANCTIONS OF THE TEAM REPRESENTATIVES

1. In the exercise of their disciplinary action, the Referees may resort to the following sanctioning forms and procedures:
 - 1.1 **VERBAL WARNING**, in the cases of the infractions and procedures specified in paragraphs 2 and 3 of Article 30 of these Rules.
 - 1.2 **BLUE CARD** complemented by the procedures established in paragraphs 2.1 e 2.2 of Article 32 of these Rules.
 - 1.3 **RED CARD** complemented by the procedures established in paragraphs 2.1 e 2.2 of Article 33 of these Rules.
2. If, before the start of the match, a player or other representative of a team is definitively expelled by the MAIN REFEREES, it may be substituted in the official Match report, but the MAIN REFEREES will have to prepare a report with the details of the events that determined such sanction.
3. If during the interval of a match, a player or other representative of a team is definitively expelled by the MAIN REFEREES, they will have to apply- *before the restart of the match*- the procedures established in paragraphs 2.1 e 2.2 of Article 33 of these Rules.
4. In the final part of the matches, more complicated situations may occur, and it is important that the MAIN REFEREES do not lose sight of the facts and serenely take the most correct decisions, without hesitating- *whenever necessary* -to exchange short words, one with the other, to define the best decision to take, particularly if there have been tumults or generalized protests, in which it is important that the MAIN REFEREES support each other and keep in communication.
 - 4.1. In the "OFFICIAL MATCH REPORT" the disciplinary action exercised by the Referees must be registered, regarding all the verbal warnings and the exhibition of the different cards (*blue and red*).
 - 4.2. In what concerns each red card exhibited directly, the MAIN REFEREES will have to elaborate a "CONFIDENTIAL REPORT", which will detail, clearly and rigorously, the situations and circumstances that led to the expulsion from the match of the offenders.
- 5 The MAIN REFEREES have to be very rigorous in the disciplinary control of the representatives of the teams that are on the "reserve bench" - *control in which the AUXILIARY REFEREE must also collaborate*-not allowing to remain standing more than three (3) authorized representatives and always punishing, with severity, all protests or disagreement attitudes - *made publicly* -in relation to the refereeing decisions.
 - 5.1 In relation to the MAIN COACH of each team, the MAIN REFEREES must consent to an "enlightening dialogue" about their decisions, this being of short duration and carried out correctly, without allowing a long dialogue that could be understood as a public protest.
 - 5.2 Regarding the **players**- *including the team captain (whether or not he is on the rink)* - and **all the other team representatives** registered in the OFFICIAL MATCH REPORT, the MAIN REFEREES will not be able to give respite to all those who - *in protest with a refereeing decision* -reveal a public discordance with their decisions, a behaviour that will have to be sanctioned in accordance with paragraphs 5.3 and/or 5.4 of this Article.
 - 5.3 If any of the offenders uses curse words and/or gestural or verbal insults to any of the Referees and/or to any of the members of the OFFICIAL TABLE OF GAME, the MAIN REFEREES always have to sanction them with a red card, implying - *for the offender and its team* -the additional sanctions provided for in paragraph 2 of Article 33 of these Rules.
 - 5.4 If any of the offenders DOES NOT USE curse words and / or insults, manifesting, nevertheless, an indisputable discordance of an arbitration decision, the MAIN REFEREES will always have to sanction them in accordance with the provisions of paragraph 3 of Article 30 of these Rules
- 6 **TEMPORARY SUSPENSIONS - SANCTIONNING OF INFRINGEMENTS OF PLAYERS OR GOALKEEPERS**
 - 6.1 When a BLUE CARD is shown to a PLAYER or to a GOALKEEPER, the MAIN REFEREES must suspend it temporarily from the game for a period of two (2) minutes.
 - 6.1.1 Any and all temporary suspension of a player or goalkeeper shall be fully fulfilled in one of the chairs that are placed after the "reserve bench" and next to the OFFICIAL TABLE OF THE GAME.
 - 6.1.2 It is not allowed, in any case, that a temporarily suspended player or goalkeeper remain on the "reserve bench" of his team.



- 6.2 If there is a violation of the provisions of paragraph 6.1.1 of this Article, the AUXILIARY REFEREE must ensure the following procedures:
- 6.2.1 Go immediately to the offender and ensure her/his return to the chair next to the OFFICIAL TABLE OF THE GAME.
- 6.2.2 If the offender refuses to comply with his obligations, the AUXILIARY REFEREE must immediately sound a signal - *interrupting the match, if it is the case*- in order to inform the MAIN REFEREES of the facts. Then, the MAIN REFEREES will display a RED CARD to the offender, expelling her/him from the match.
- 6.3 If- *in addition to the infringement of paragraph 6.1.1 of this Article*-the player or goalkeeper unduly enters the rink when her/his team is playing in "inferiority"- *replacing a colleague of his team before having fulfilled the entire time of suspension* - the AUXILIARY REFEREE must immediately trigger a sound sign - *interrupting the match, if it is the case* -in order to inform the MAIN REFEREES about the infraction. Then, the MAIN REFEREES will have to ensure the following procedures:
- 6.3.1 To display two (2) RED CARDS, definitively expelling the OFFENDER and the MAIN COACH from the game or - *in her/his absence and in order of preference* -the ASSISTANT COACH, or one DELEGATE or the PLAYER WHO IS THE TEAM CAPTAIN.
- 6.3.2 The offending team will have to play two(2)"inferiority periods", as provided in paragraph 1 of Article 18 of these Rules.
- 6.3.3 The restart of the game will be carried out in the following way:
- a) If the match was interrupted by the MAIN REFEREES due to the offense in question, a **direct free hit** will be executed against the team of the offenders.
- b) If the match was not active at the time of the offense in question, **the restart of the match will be made based on the action that caused the interruption in question**
- 6.4 If the improper entry into the rink of a player of a team playing a "period in Inferiority" - *before receiving the authorization for that* -the AUXILIARY REFEREE will have to immediately trigger an audible signal so that the MAIN REFEREES will be warned of the infraction and - *after interrupting the match, if it is the case* -can apply the same procedures that are defined in paragraphs 6.3.1, 6.3.2 and 6.3.3 of this Article.
- 6.5 However, when the improper entry on the rink by a Player or goalkeeper has occurred due to an error or mistake of the AUXILIARY REFEREE - *and that is recognized by him and by the MAIN REFEREES* -these will have to apply the procedures provided in paragraph 2.2.1 of Article 36 of these Rules, considering cancelled any disciplinary action that, in the meantime, has been carried out.

ARTICLE 18- DISCIPLINARY SANCTIONS OF THE TEAMS - TO "PLAY IN INFERIORITY"

1. DISCIPLINARY SANCTIONING OF THE TEAMS - DEFINITION AND GENERAL RULES

- 1.1 During a match, playing a "period in inferiority" is the disciplinary sanction that - *although temporarily* - penalizes the teams whose representatives commit serious and or very serious disciplinary offenses.
- 1.2 During anyone of the "periods of inferiority", **any team will have to ensure a total of four(4) players on the rink, including a goalkeeper**(*safeguarding the established in paragraph 5.2. of Article 20 of these Rules*).
- 1.3 Relating to the infractions committed, the MAIN REFEREES will have to ensure:
- 1.3.1 The immediate sanction of the offenders, depending on the severity of their behaviour and controlling (*if this is the case*) their withdrawal from the rink and leaving the area of the "reserve bench" of their team (*if a red card display was displayed*)
- 1.3.2 The execution of the substitutions that are necessary for the match to proceed, considering what is established in paragraph 1.2 of this Article, a situation that, if not fulfilled, will determine the immediate suspension of the match and its completion, in accordance with paragraph 5 of Article 8 of these Rules.
- 1.3.3 When a disciplinary sanction is applied to other team representative- *or to a player* -who is on the "reserve bench", the corresponding sanction of the team with a "period in inferiority" will imply that his MAIN COACH has to withdraw a player from the rink, having in mind that:
- a) In this specific case, the player removed from the rink will occupy the team "reserve bench", once he was not sanctioned.
- b) Consequently, this same player may return to the match to substitute a teammate, when his MAIN COACH has decided it (*maintaining only 4 players in the rink, if it is the case*).



1.4 When a "period in inferiority" of a team expires, its Delegate will immediately be informed by the AUXILIARY REFEREE.

2. CANCELLATION OF A "INFERIORITY PERÍOD" WHEN THE PUNISHED TEAM SUFFERS A GOAL

- 2.1 If the team that plays a "period in inferiority" suffers a goal, it can proceed to the immediate entry on the rink of a new player, but never the re-entry of a player who is excluded or fulfilling a temporary suspension of the game, which will have to comply with the totality of the corresponding sanction.
- 2.2 The substitute player's entry into the rink may occur immediately after the conceded goal - *in the sequence, for example, of the direct free hit that has been signalled by the infringement that gave rise to the "inferior period" in question*- a situation which, in practical terms, it ends up not happening.
- 2.3 However, when a valid goal favours the team that is sanctioned with a "period in inferiority", no consequence occurs in the established sanction, once the team in question has to keep playing in "inferiority".
- 2.4 Safeguarding what is established in paragraph 4 of Article 23 of these Rules, when a goal obtained by a Player in his own goal occurs - *as a result of a deliberate and deliberate action, at a time when his team was serving a "period in inferiority"* - the goal in question may not have any effect at the end of the "inferior period" in question.

3. COMPLIANCE WITH ONE OR TWO DISCIPLINARY SANCTIONS BY ONE OF THE TEAMS

- 3.1 When, in a given moment of the match, a single infraction occurs, the corresponding "period of inferiority" may be one of the following:
- 3.1.1 "Period of inferiority" with the maximum duration of two(2)minutes, when the team offender is sanctioned with a **BLUE CARD**.
- 3.1.2 "Period of inferiority" with the maximum duration of four(4)minutes, when the team offender is sanctioned with a **RED CARD**.
- 3.1.3 The beginning of the "period of inferiority" (*playing time*) occurs when the Main Referees restart the match, after ensuring the provisions of paragraphs 1.2 and 1.3 of this Article.
- 3.1.4 The end of the "period of inferiority" (*playing time*) occurs when:
- the sanctioned team suffers a goal; or**
 - the maximum time of its duration is exhausted.**
- 3.2 When - *at the same moment of the game, or at another time* - **a representative of the same team commits a second infraction**- *which is sanctioned with a blue card or with a red card* - **his team will have to be sanctioned with a second "period in inferiority"**, which will have to be arranged by the MAIN REFEREES in the following way:
- 3.2.1 To comply with the provisions of paragraphs 1.2 and 1.3 of this Article.
- 3.2.2 If the match can continue, the team of offenders is sanctioned with an **additional "period of inferiority"**, with the maximum duration of:
- Two(2)minutes**, if a **blue card** was displayed to the team's infractor; or
 - Four(4)minutes**, if a **red card** was displayed to the team's infractor.
- 3.2.3 This second "inferiority period" will have its beginning (*playing time*) when occurs the end of the first "period of inferiority".
- 3.2.4 The end of the second "period in inferiority" will occur (*playing time*) in accordance with the provisions of paragraph 3.1.4 of this Article.

4. COMPLIANCE WITH THREE OR MORE DISCIPLINARY SANCTIONS BY ONE OF THE TEAMS

When - *at different times or at the same moment of the match* - the same team suffers a third or any additional disciplinary sanctions, before the two previous "periods in inferiority" have been completed, the MAIN REFEREES will have to ensure:

- 4.1 The compliance with what is established in paragraphs 1.2 and 1.3 of this Article.
- 4.2 If the match can continue, the team of offenders is sanctioned with:
- 4.2.1 An additional "period of inferiority" for each one of the infractions committed by their representatives, each of them with an additional duration of five(5)minutes, regardless of the sanction (*blue card or red card*) that has been exhibited to the team infractions in question.



4.2.2 Each one of the additional team "periods of inferiority" will have its start at the same time (*playing time*) that occurs the end of the previous "period in inferiority".

4.3 The end of each one of the additional "periods in inferiority" will occur (*playing time*) in accordance with the provisions of paragraph 3.1.4 of this Article.

5. TEAMS IN PARITY - DISCIPLINARY SANCTIONS WHEN SIMULTANEOUS INFRACTIONS OCCUR

5.1 When the two teams are in parity - *that is, they have the same number of players on the rink* - and occurs, at the same moment of the match, the suspension (*blue card*) or exclusion of the match (*red card*) of the same number of each team representatives (*players and/or others*), the disciplinary sanction of the "period in inferiority" will not be applied and the following procedures must be ensured:

5.2 Each team has to secure the necessary substitutions to re-establish the parity of the number of players who were on the court prior to the infractions in question.

5.3 When one or both teams do not have enough substitutes available to restore parity, each team must comply with the sanction that corresponds to it, without the substitution of any of the offenders in question, safeguarding what is established in paragraph 1.3.2 of this Article

5.4 When- *before the restart of the game, but after the substitutions mentioned in paragraph 1.2.2 of this Article, they have already occurred* -there is the occurrence of an additional sanction (*red or blue card*) that is exhibited to a representative of one of the teams- *or an additional foul practiced by the same or another offender* -the MAIN REFEREES must ensure the following additional procedures:

5.3.1 To sanction the team of the offender with the corresponding additional "period of inferiority", considering the provisions of paragraph 4 of this Article.

5.3.2 To perform the cancellation of the substitutions previously made, considering that - *if it is true that the two teams will have four (4) players on the rink*- -when restarting the match one of the teams has to fulfil two "periods" of inferiority "and the other team only has to fulfil a" period in inferiority".



CHAPTER VI - SPECIFIC SITUATIONS OF THE GAME

ARTICLE 19 - STARTING AND RESTARTING OF THE MATCH

1. In all the situations, the game always starts and ends at the sound of the Referee's whistle and the Timekeeper's sound signal is merely indicative.
2. At the beginning of each one of the periods of the match - *and whenever a goal is scored*- the ball is placed at the centre of the central circle, executing the corresponding CENTRE PASS, after the whistle of the MAIN REFEREES, having in mind the following:
 - 2.1 In accordance with what is established in paragraph 2.2 of Article 6 of these Rules, it is the "visiting" team - *or as such considered ("Team 2")* -which is always responsible for the execution of the INITIAL CENTRE PASS of the first period of the match or of its first period of extra-time, corresponding to the "visited" team - *or as such considered ("Team 1")* -to execute the CENTRAL PASS in the beginning of the second period of the match or of its second period of extra-time.
 - 2.2 After a goal is considered valid, the team that suffered it resumes the game by means of a CENTRE PASS, except for the validation of any goal that is obtained during any tie-break of the match, as established in paragraphs 3.5 and 5.5 of Article 3 of these Rules.
3. When a CENTRE PASS is being executed, all players must be on their defensive zone, and only two(2) of them - *the executing player and one of her/his team mates* -being allowed to stay inside the central circle.
 - 3.1 After the whistle of the MAIN REFEREES, the ball will be in play, allowing the opposing players to touch the ball if the performing player is slow to play it.
 - 3.2 In the execution of any CENTRE PASS the ball can be sent to the opposite half-rink or to stay in the defensive zone of the executing team, which will have five (5)seconds to pass the ball to the opposite half-rink, whose infraction will be sanctioned by the MAIN REFEREES as established in the paragraph 1.1.4 of Article 15 of these Rules.
4. If the player in charge of the execution of the CENTRE PASS decides, after the whistle of the Referee, to send the ball directly to the opponent goal cage and manages to score a goal - *without the ball having been touched by any other player* -the MAIN REFEREES cannot validate it and will resume the game with a FACE-OFF to be executed in one of the lower angles of the surface area of the goal cage in question.

ARTICLE 20 - ENTERING AND LEAVING THE RINK - PLAYERS SUBSTITUTION

1. The players of each team - *including goalkeepers* - will enter and leave the rink through the gate next to their reserve bench in order to carry out any substitution, bearing in mind that, when the match is active, the substitute player may not enter the rink before the other left.
2. **ENTERING OR LEAVING THE RINK JUMPING THE FENCE**
 - 2.1 When a goalkeeper or floor player, in the action of the game itself, falls over the barrier, the Main Referees may allow him to jump the fence to get back in the game.
 - 2.2 A goalkeeper, rink player or other team representative cannot jump over the fence without prior and specific authorization from the MAIN REFEREES, whereby - *when any infraction occurs*-the MAIN REFEREES will have to immediately interrupt the match - *if this is active* - in order to ensure- *even if the match was not active* -the sanctioning procedures that are established for this specific infraction, that is:
 - 2.2.1 In the case of a first offence committed by the representative concerned, the offender shall be warned with a verbal warning, in accordance with the provisions of paragraph 3.1 of Article 30 of these Rules
 - 2.2.2 If the offender in question is a repeated offender in one of the infractions punishable by verbal warning, one of the sanctions established in paragraph 3.2 of Article 30 of these Rules will have to be applied.
 - 2.3 If a player enters on the rink jumping the barrier - *being responsible for an "irregular substitution"*-this will be considered a major foul, which will be punished by the MAIN REFEREES as established in paragraph 6 of this Article.



3. OBLIGATORY SUBSTITUTIONS

- 3.1 Except when there are no reserves available, a goalkeeper or player who received assistance on the rink must be substituted, even if he is physically apt to continue in play.
- 3.2 Without prejudice of paragraph 1.3 of Article 21 of these Rules, whenever the equipment of a goalkeeper on the rink is found out to be damaged, the Main Referees must stop the game immediately and order her/his substitution by the reserve goalkeeper, except when there is no substitute goalkeeper available.
- 3.2.1 It is not obligatory to substitute the goalkeeper when, availing a stoppage in play, he asks the Main Referees permission to go to her/his reserve bench in order to clean the visor of her/his helmet, adjust the straps of her/his leg-pads or another piece of her/his protective equipment.
- 3.2.2 While a "time-out" is running, or assistance is given to an injured player or goalkeeper on the rink, the goalkeeper does not need to ask previous permission to the Main Referees in order to clean her/his visor or adjust her/his equipment.
- 3.3 Except for paragraph 3.2.2 of this Article, whenever a goalkeeper on the rink goes to her/his reserve bench to clean her/his visor - or for any other reason -without requesting the Main Referees' permission, they will apply:
- 3.3.1 The procedures set out in paragraph 3 of Article 30 of these Rules.
- 3.3.2 The obligatory substitution of the offending goalkeeper by the reserve goalkeeper, except when there is no substitute goalkeeper available.

4. SUBSTITUTIONS - GENERIC RULES

Substitutions may be carried out while play is in progress or during a stoppage, according to the established in the following paragraphs.

- 4.1 When a substitution is carried out while the match is in course, the player or goalkeeper may not enter the rink before the other player or goalkeeper has left the rink, a situation which - *in the case of a violation* -will have to be sanctioned by the ~~players~~ MAIN REFEREES as provided in paragraph 6 of this Article.
- 4.2 Substitutions are allowed before the MAIN REFEREES conclude the positioning of the players for a penalty shot or a direct free hit, but none of the teams may perform substitutions after the permission to execute them, a situation which - *in the case of an infraction* -will have to be sanctioned by the MAIN REFEREES as follows:
- 4.2.1 If the execution of the direct free kick or penalty has not yet begun, it is necessary to ensure the immediate interruption of the match and the following actions:
- a) to display two(2)red cards, definitively expelling from the match the player who had entered the rink irregularly and the team MAIN COACH or - *in her/his absence and in the following order* -the ASSISTANT COACH, or one of the team DELEGATES or the CAPTAIN on the rink.
- b) to sanction of the offending team with two (2)"periods in inferiority"- according to the provisions of paragraph 1.4 of Article 18 of these Rules -without having any technical sanction of the offending team.
- 4.2.2 If the execution of the direct free hit or of the penalty has already begun and a goal is obtained, the MAIN REFEREES must ensure:
- a) The procedures indicated in the paragraph 4.2.1 a) and b) of this Article;
- b) The validation of the goal obtained, restarting the match with the corresponding centre pass.
- 4.2.3 If the execution of the direct free kick or penalty has already begun and a goal is not obtained, the MAIN REFEREES must ensure the procedures indicated in the paragraph 9.5.3 of Article 35.
- 4.3 The goalkeepers - *registered, as such, in the official Match Report* -may only substitute another goalkeeper, except - *as provided in paragraph 5.2 of this Article* - in the case of the replacement of a rink player, **either in the last five (5)minutes of the second period of the normal playing time, or in the last minute of the second period of the extra-time.**
- 4.4 The re-entry of any goalkeeper or of a rink player that has to be assisted on the rink may only occur after the game has been re-started by the MAIN REFEREES.

5. SPECIFIC RULES TO CONSIDER WHEN REPLACING A GOALKEEPER

Goalkeepers may be replaced under the same conditions as floor players. However, a team may choose to ask the Main Referees to be allowed 30 (*thirty*)seconds to carry out the substitution by the reserve goalkeeper, making use of a stoppage in the game.



- 5.1 When - *for a disabling injury or disciplinary reasons*--the goalkeeper on the rink must be replaced and there is no reserve goalkeeper available, the MAIN REFEREES will allow three(3)minutes for another player to take her/his place and put on the goalkeeper's special protection equipment.
- 5.1.1 If - *when there is no other option* -the replaced goalkeeper refuses to give her/his special protection equipment to the player who would substitute him, the Main Referees must request the intervention of the captain on the rink and/or of the team delegates to solve the situation rapidly.
- 5.1.2 If their endeavours do not result, the Main Referees will end the game and write a detailed report of the facts on the official Match Report.
- 5.2 As a technical option, a goalkeeper may be replaced by a floor player of the same team, in conformity with the following restrictions (*):
- 5.2.1 This replacement is only allowed during the following two time periods:
- In the last five(5)minutes of the second period of the normal play time;
 - in the last minute of the second period of extra-time.
- 5.2.2 The replacing player cannot benefit of the special goalkeeper's rights when defending her/his cage, neither is he allowed to use the goalkeeper leg guards and her/his special protective equipment.

(*) **Important note:** *If occurs the substitution of the goal-keeper by a rink-player outside the indicated permitted times, it will have to be considered as an "irregular substitution, punishable as it is established in the paragraph5.3 of this same Article.*

- 5.3 If a player improperly enters the rink to replace a goalkeeper before the time set out in paragraph 5.2 of this Article, the following procedures shall be considered:
- 5.3.1 **When the action occurs with the match active and in progress**, the AUXILIARY REFEREE must immediately make a sound warning to notify the MAIN REFEREES about the occurrence of an infraction, who must apply, immediately after, the following procedures:
- the display of two(2)red cards, definitively expelling from the match the player who had entered the rink irregularly and the team MAIN COACH or - *in her/his absence and in the following order* -the ASSISTANT COACH, or one of the team DELEGATES or the CAPTAIN on the rink.
 - to sanction of the offending team with two (2)"periods in inferiority in conformity with what is established in paragraph 1.4 of Article18 of these Rules.
 - the restart of the match will be carried out with the execution of a direct free hit against the team of the offenders.
- 5.3.2 **When the action occurs when the game is stopped or interrupted**, the AUXILIARY REFEREE and the MAIN REFEREES must interfere immediately in order to correct the situation, so that a goalkeeper of the team in question - *the one that had left the rink or a substitute goalkeeper* -re-enter immediately in the rink to replace one of the other players, without any disciplinary action being taken.

6. IRREGULAR SUBSTITUTION AND SANCTIONING OF THE INFRINGERS

- 6.1 When the game is stopped or interrupted can never be considered an irregular substitution, which means that the Main Referees cannot order the restart of the game without verifying if all the conditions are fulfilled in accordance with the applicable rules.
- 6.2 When the match is active and in progress and there is an irregular substitution, the referees must ensure -*safeguarding what is established in the following paragraphs*- the display of a blue card to the player or substitute goalkeeper, his team being sanctioned with the corresponding "Period in inferiority", in accordance with the Article 18 of these Rules.
- 6.3 If occurs an improper entry on the rink of a player or goalkeeper not authorized to do so - *either because he was temporarily or permanently excluded from the match, or because he had not previously been registered in the official Match Report* - the Auxiliary Referee have to ensure what is established in paragraphs 6.2 and 6.3 of Article 17 of these Rules.
- 6.4 When the match was interrupted by the Main Referees to ensure the disciplinary action resulting from any irregular substitution, the match will have to be restarted with the execution of a direct free hit against the team of the offending player or goalkeeper.



ARTICLE 21 - GOALKEEPERS' ACTION IN THE GAME

1. BASIC POSITION OF A GOAL KEEPER AND ACTIONS IN DEFENSE OF HER/HIS GOAL CAGE

- 1.1 Like the rest of the players, the goalkeeper must perform her/his role standing on her/his skates, being allowed to keep one of her/his knees resting on the ground, except when a penalty shot or a direct free hit is taken against her/his team, as specified in Article 35 of these Rules.
- 1.2 However, when in defence of his goal cage - *during the attempt to defend a shot or to prevent her/his team from suffering a goal* - the goalkeeper the goalkeeper is allowed to kneel, sit, lie or crawl, and stop the ball with any part of her/his body, even in temporary contact with the rink.
- 1.3 If the goalkeeper drops any component of her/his protection equipment - *face mask or helmet, gloves, shin guards* - and thus defends a shot at her/his goal cage, there will be no signing of any foul and the MAIN REFEREES shall apply the "ADVANTAGE LAW". Nevertheless, after the end of the action, the MAIN REFEREES-must interrupt the match and allow the goalkeeper to insure the replacement of the protection equipment in question.

2. INFRACTIONS OF A GOAL KEEPER IN DEFENSE OF HER/HIS GOAL CAGE

- 2.1 In defence of her/his goal, the goalkeeper is not allowed:
 - 2.1.1 To Grab or catch the ball with the hand
 - 2.1.2 To lye - *intentionally* - on top of the ball
 - 2.1.3 To hold - *intentionally* - the ball between the legs, preventing the ball from being played.
- 2.2. Whenever any of the infractions established in paragraph 2.1 of this Article occurs, the MAIN REFEREES will interrupt the game immediately and will sanction with a penalty shot the team of the offending goalkeeper, without any disciplinary action being taken.

3. GOAL KEEPER ACTION OUTSIDE HIS/HER GOAL CAGE AREA

When the goalkeeper is with her/his body completely outside the goal area, the goalkeeper may not use in an intentional way her/his specific protection instruments, which will be subjected to the following penalties:

- 3.1 If the goalkeeper intentionally plays the ball with the gloves or guards, the game will be interrupted immediately by the MAIN REFEREES, who will show a blue card to the offending goalkeeper, ensuring the compliance with the sanctions established in paragraph 2 of Article 32 of this Rules.
- 3.2. If the goalkeeper plays the ball irregularly - *or if, unintentionally, the ball touches his protective guards* - the MAIN REFEREES must sign - *if there was no room for the application of the "ADVANTAGE LAW"* - an **indirect free hit** against the offending team, without any disciplinary action being taken.

4. GOAL KEEPER INFRACTIONS OUTSIDE HIS/HER GOAL CAGE AREA

When the ball is in an area behind its goal area, some fouls of the goalkeeper may occur, situations that require the MAIN REFEREES to interrupt immediately the match and to sanction the infractions in the following way:

- 4.1 To sign a team fault - *with execution of the corresponding indirect free (if applicable) in the lower corner of the goal area that is closest to the place of infringement* - provided that the goalkeeper in question hits with his stick:
 - a) The stick of an opponent rink player;
 - b) The zone of the skates and/or of the shin guards of the adversary player, without causing the knockdown on the rink and/or without using the violence in the action.
- 4.2 To sign a technical fault - *with the execution of the corresponding indirect free hit in the lower corner of the goal area that is closest to the place of infringement* - without any additional action of a disciplinary nature, when playing the ball irregularly with his stick, not being supported exclusively on his skates, keeping one or both knees resting on the ground
- 4.3 To sign a direct free hit - *after showing a blue card to the offending goalkeeper*- whenever he hits her/his stick to an opponent player in the skates and/or the protective shin guards, causing a knockdown on the rink.
- 4.4 To sign a direct free hit - *after showing a red card to the offending goalkeeper*- whenever he hits an opposing player with his stick, attacking him in unprotected area of the body (*legs, arms, trunk, etc.*)

5. GOAL SCORED BY A GOALKEEPER

When the goalkeeper makes a correct intervention and not at fault in defending their goal, impacting the ball that, as a result, enters directly into the opponent's goal, without being played or touched by any other player, the goal thus obtained must be validated by the MAIN REFEREES in accordance with what is established in paragraph 1.2.4 of Article 23 of these Rules.



ARTICLE 22 - PLAYING THE BALL - SPECIFIC RULES

1. PLAYING OR SHOOTING THE BALL WITH THE STICK - REFEREEING PROCEDURES

- 1.1 Safeguarding what is established in paragraph 1 of Article 21 of these Rules, the ball may only be played with the stick, having in mind that - *every time the player is out of the penalty area of both teams* - he can stop the ball with her/his skates or with any part of her/his body, but never with the hand.
- 1.2 Except for the goalkeepers and the situations of shots of the players to the opponent's goal cage, within the area of that team, the ball can only be moved with the flat parts of the "stick", being prohibited to "cut" the ball, that is, the ball cannot be moved with the sharp edge of the stick.
- 1.3 When a Player raises his stick above the level of his own shoulder, the Main Referees will consider the following situations:
 - 1.3.1 To punish as a technical fault when the lifting of the stick is considered dangerous for the Referees and/or any player on the rink (from the opponent or from their own team)
 - 1.3.2 To consider the validity of the action when a player- after having raised his stick without endangering the Referee and / or other players on the rink -controls the ball and decides to impact it in the direction of a teammate or in the direction of the opposing goal, trying to score a goal.
- 1.4 Cannot be validated any goal that is obtained in consequence - *accidental or not* - of a bounce of the ball in any part of the body or in the skates of a Player of the team that could benefit from the goal in question.
- 1.5 However, any goal obtained as indicated below must always be validated:
 - 1.5.1 A goal that is obtained in the circumstances established in paragraph 1.3.2 of this Article.
 - 1.5.2 A goal that is obtained by a player in his own goal, either with his stick or, in consequence - *accidental or not* - of a bounce of the ball in her/his skates and/or in any part of her/his body.

2. INTERVENTION OF PLAYERS WITH IRREGULARITIES IN THEIR EQUIPMENT - SANCTIONING

- 2.1 With the exception of the provisions of paragraph 3.2 of this Article, the MAIN REFEREES must interrupt the match and point out the corresponding team fault - *which is sanctioned with a verbal warning, according to what is established in paragraph 3 of Article 30 of these Rules* - when a rink player or a goalkeeper plays the ball - *or takes an active part in the game* - with his equipment in an irregular state and when one of the following circumstances is verified:
 - 2.1.1 To play the ball intentionally without a stick
 - 2.1.2 To play the ball when one of the skates is damaged (*e.g. loss or blocking of a wheel, skate separated from the boot, etc*)
 - 2.1.3 A goalkeeper who plays or defends the ball without wearing all its protective elements (*full protection mask or helmet and visor, bib, two gloves and two goalkeeper shin guards*)
- 2.2 If a rink player has her/his equipment in irregular conditions, but has no active intervention in the game, no interruption will be made by the MAIN REFEREES, who will take advantage of an interruption of the match to force the substitution of the player in question.

3. RESTRICTIONS ON THE INTERVENTION OF PLAYERS TO MOVE THE BALL

- 3.1 The MAIN REFEREES must interrupt the match and point out a technical foul - *which will be sanctioned in accordance with the provisions of Article 29 of these Rules* - when a player commits any of the following infractions:
 - 3.1.1 To play the ball when - *besides the skates* - has her/his hands or any other part of the body touching the ground, except for the goalkeeper when he is in her/his goal cage area.
 - 3.1.2 To play the ball with the hands, arms or any other part of the body
 - 3.1.3 To stop the ball with your hand or kick it intentionally.
 - 3.1.4 Immobilize the ball between the fence and the skates or between the fence and the stick.
 - 3.1.5 To play the ball when it is supported or held to a goal cage, except for the goalkeeper when she/he is in the goal cage area.
 - 3.1.6 To stand with the back to the rink, keeping possession of the ball, at any corner of the rink or just behind a goal.



3.2 With the exception of the goalkeeper when she/he is in his goal area, the ball may not be raised more than 1.50 meters high.

3.2.1 In the event of such an infraction, the MAIN REFEREES will sanction the offender's team with an INDIRECT FREE HIT, even if the infraction occurs in the goal area of the offender's team.

3.2.2 However, as long as the ball does not leave the rink, no infraction will be considered when the ball rises due to a rebound, either in the goal cage or in the hurdles, in the body, in the "stick" and in the skates of a rink player.

4. DEFECTIVE BALL

When a ball becomes defective, the MAIN REFEREES will interrupt the match, proceeding to its replacement by a new ball and they resumed the game with free indirect hit to be executed by the team that had possession of the ball when the match was interrupted.

5. BALL "IN PLAY"

5.1 It is considered a "ball in play" when the MAIN REFEREES whistle to start or resume the game or when - *after a game interruption by the MAIN REFEREES to signal an indirect free hit* - the Player who benefits from the fault touches the ball.

5.2 It was also considered that the ball is in play when accidentally touches the MAIN REFEREES or when accidentally rises to more than 1,50 meters, after hitting the fences or a goal cage or due to a goalkeeper defence or also after a bouncing between two "sticks".

6. BALL "OUT OF PLAY"

It is considered the "ball out of play" provided that the game has been interrupted by the MAIN REFEREES by force of one of the following situations:

6.1 THE BALL COMES OUT OF THE RINK OR STAYS AMONG THE FENCE AND THE FENCE PROTECTION

If the ball goes out of the rink, either by having been intentionally thrown by a player or by accidentally touching it, or by having been shot against the crossbar or the goal posts, the match will be immediately interrupted by the MAIN REFEREES, who must order - *always using a whistle* - the resumption of the match in accordance with the following two alternatives:

6.1.1 The execution of an INDIRECT FREE-HIT, sanctioning the team of the offender, when the MAIN REFEREES do not have doubts about the identification of the player who was responsible for putting the ball out of play; or

6.1.2 The execution of a FACE-OFF, when the MAIN REFEREES are not sure about the identification of the responsible for putting the ball out of play.

6.2 THE BALL IS INSIDE THE GOALKEEPER'S LEG GUARDS OR IN ANY OUTSIDE PART OF A GOAL CAGE

In these situations, the MAIN REFEREES will interrupt the game, resuming it later with the execution of a FACE-OFF in one of the lower corners of the goal cage of the goalkeeper in question.

6.3 THE BALL TOUCHES THE CEILING OF THE PAVILION

When the ball touches the ceiling - *which may occur as a result of a goalkeeper's stoppage or as a result of a shot hitting the goal cage posts or when the MAIN REFEREES have doubts about which offender is* - the game will restart with a FACE-OFF on the centre of the rink.

ARTICLE 23 - OBTAINING AND VALIDATING A GOAL

1. VALIDATING A GOAL

1.1 In regular playing conditions, a goal is scored each time the ball has completely crossed the "goal line", marked between the two posts and under the top beam, into the cage, without the ball having been thrown, transported or kicked with the foot or some other part of the attacking player's body.

1.2 A goal will always be valid if scored from:

1.2.1 A regular shot, from any part of the rink, unless it immediately enters the cage as a result from an indirect free hit or a centre pass, without having been touched or played by another player.

1.2.2 A regular face-off, also when the ball immediately enters the goal cage, without having been touched or played by another player.

1.2.3 A goal scored by a player in her/his own team's goal cage, either with her/his stick or some part of her/his body, regardless of her/his position on the rink.



- 1.2.4 A goal scored by the opponent goalkeeper, after a valid and regular intervention for defending her/his goal cage, with the ball going directly to the opponent goal cage, without having been touched or played by another player.
- 1.3 When the ball rises above 1, 50 meters - *after rebounding off the posts or top beam of the goal cage, or the boards around the rink* -and then falls on the goalkeeper's back and enters the cage, the Main Referees will validate the goal as no foul was committed by the player who struck the ball.
- 1.4 If a goalkeeper of the defending team throws her/his stick, mask or glove, in an attempt to prevent the ball from entering the cage, but without succeeding, the MAIN REFEREES will allow the goal and take disciplinary action against the offender, in conformity with paragraph 8.3.1 b)of Article 27of these Rules.

2. INVALID GOALS

2.1 A GOAL IS NOT VALID WHEN SCORED FROM:

- 2.1.1 A rebound in any part of the body or in the skates of a team player that it would benefit, regardless of this goal have been obtained because of an accidental or unintentional action of the player concerned.
 - 2.1.2 An indirect free hit, as the ball enters directly in the opponent's goal cage, without having been touched or played by another player.
 - 2.1.3 A centre pass, as the ball enters directly in the opponent's goal cage, without having been touched or played by another player.
 - 2.1.4 An intervention from outside the game, having unduly entered the rink.
 - 2.1.5 The execution of a player who - *having possession of the ball behind the opponent's goal cage* - decided to raise it and hit it above the goal cage.
- 2.2 In every situation described in the previous paragraphs, the game will restart with a FACE-OFF, which will always be executed in one of the lower corners of the penalty area in which a non-valid goal was scored.

3. GOAL SCORED AT THE END OF THE MATCH OR AT THE END OF THE FIRST PERIOD

If a "valid goal" is scored at the exact moment when the Official Table signals the end of the first period or of the match, the Main Referees must ensure that the goal is officially validated, by ordering the "centre pass" and whistling immediately to signal the end of the period or match.

4. INTENTIONAL SCORING IN OWN CAGE

If a player or goalkeeper intentionally scores a goal in her/his own team's cage, the Main Referees will always validate the goal, however - *in addition* -they must carry out the following procedures:

- 4.1 Award two (2)red cards, one to the Player or Goalkeeper responsible for the goal in the team's own cage and the other to the MAIN COACH or - *in her/his absence and in the following order* -to the Assistant Coach, or one of the team Delegates or the Captain on the rink.
- 4.2 Sanction of the offenders' team with two different "periods in inferiority", having in mind what is established in the paragraph 1 of Article 18 of these Rules.

ARTICLE 24- BLOCKING AND OBSTRUCTION

1. BLOCKING

Legal tactical action carried out by an attacking player, who -*within the opponent's field of vision and without any physical contact* -tries to prevent an opponent from obtaining a defensive but favourable position, and thus hinders the efficacy of her/his action.

- 1.1 The "blocker" can place him/herself sideways and carry out the blocking statically (*without ball*) or dynamically (*with ball*).
- 1.2 If the blocked player is standing still, the "blocker" may carry out the blocking as close as she/he wishes, provided she/he does not make physical contact.
- 1.3 If the blocked player is on the move, the "blocker" has to give her/him enough space -*minimum distance required is 50 (fifty) centimetres*- to allow her/him to avoid the blocking, by stopping or changing direction.
- 1.4 The "blocker" may not express aggressiveness in her/his attitude. He/she must lean slightly forward and keep the stick low.



2. UNDOING A BLOCK

Useful and legal tactic in which no space is occupied by the attacking player and that is carried out with no physical contact with the opposite defending player.

3. THE CURTAIN

Another legal tactic carried out by an attacking player, who *-being the ball carrier or not -* moves ahead of a defending opponent, hindering her/him to act efficaciously against the attacking action carried out by the player who has possession of the ball.

4. ILLEGAL BLOCKING

Blocking is illegal when one of the following situations occurs:

- 4.1 The “blocker” makes physical contact with a “defensive” opponent.
- 4.2 The “blocker” assumes an “aggressive” attitude, holding her/his stick above the line of her/his own skates as a way to obtain additional space and/or intimidate the “blocked” player.
- 4.3 The “blocker” is moving and does not keep a minimum distance of 50 (*fifty*)centimetres from the player she/he is blocking or when she/he pushes or bumps into her/him.

5. OBSTRUCTION

Illegal action occurring when a player - *attacking or defending* -intentionally makes physical contact with an opponent, to prevent her/him from opposing her/his action and/or progression on the rink, as for instance:

- 5.1 Cutting or barring the way to an opponent, preventing her/him from getting away without the ball or from participating in going-on action.
- 5.2 Pressing an opponent against the barrier, to prevent her/him from playing the ball.
- 5.3 Grabbing or leaning on the goal cage or on the rail or upper part of the rink barrier, with the aim of obstruction the way to an opponent and as such hindering her/his free movement.

6. SANCTION OF ILLEGAL BLOCKS AND OBSTRUCTIONS

Illegal blocking and obstruction must be punished by the Main Referees with a “team foul” to the offending team, according to paragraph 1.2.1 of Article 31 of these Rules.

- 6.1 The MAIN REFEREES must correctly evaluate the situations of play, distinguishing between:
 - 6.1.1 Faulty and “punishable” actions - *cases of obstruction and illegal blocking* -which are committed intentionally and involve physical contact with the opponent; and
 - 6.1.2 Perfectly legal tactical actions of attacking players that, as such, enhance the game’s competitiveness and must not be punished
- 6.2 When, in the action of the game, a player is in the opponent’s way, he/she is not obliged to step aside and clear the way, being allowed to stay in the opponent’s trajectory and stand still in front of him/her, as long as he/she abstains from making any move.

ARTICLE 25 - OTHER SPECIFIC SITUATIONS OF PLAY

1. DISPLACING THE GOAL CAGE

When a goal cage is displaced, the Main Referees must act as follows:

- 1. 1 When the goal cage is intentionally displaced by a goalkeeper or player of any of the teams, the MAIN REFEREES must stop the game immediately, showing the offender a blue card, and ensure the corresponding sanctions as specified in paragraph 2 of Article 32 of these Rules, having in mind the following:
 - 1.1.1 If the goal cage was dislocated by a player of the attacking team that had possession of the ball, the MAIN REFEREES must order the execution of a direct free hit against the team of the offender.
 - 1.1.2 If the goal cage was dislocated by a player or the goalkeeper of the defensive team, the MAIN REFEREES must order the execution of a penalty against the team of the offender
- 1.2 When the goal cage is displaced unintentionally by a player of any of the teams, the Main Referees will proceed as follows:
 - 1.2.1 Try to put the cage back on its right place, to avoid stopping the game.
 - 1.2.2 When the above option is not practicable, the Main Referees will stop the game and proceed to put the cage back on its correct place. The game starts again with an indirect free hit executed by the team in possession of the ball at the moment of stoppage, safeguarding what is established in paragraph 7.1.2 b) of Article 27 of these Rules



2. FACE-OFF

- 2.1 After a stoppage ordered by the MAIN REFEREES, the game starts again with a face-off in the following circumstances:
- 2.1.1 When the stoppage was not due to a foul being signalled and when the MAIN REFEREES are uncertain as to which of the teams had possession of the ball at the moment of stoppage.
- 2.1.2 When the stoppage was due to the signalling of two fouls of identical gravity and committed simultaneously by players of both teams.
- 2.2 To execute a face-off, two players, 1 (*one*) of each team, will stand facing each other, their backs to their own half of the rink and sticks resting on the floor at a minimum distance of 20 (*twenty*) centimetres from the ball.
- 2.2.1 Except for the players who take part in the face-off, all players must be at a distance of at least 3 (*three*) metres from the place of the take-off.
- 2.2.2 When a face-off takes place, the players may only touch the ball after the referee's whistle.
- 2.2.3 If the ball is moved by one of the players before the referee whistles, an indirect free hit will immediately be signalled against the offender's team, to be taken at the same spot.
- 2.3 The place where the face-off is taken will be indicated by the Main Referees, depending on the place where the ball was at the moment of stoppage, without prejudice of the following specific situations.
- 2.3.1 After a non-valid goal, scored irregularly from a centre pass or an indirect free hit, the face-off will be conducted in one of the lower corners of the penalty area.
- 2.3.2 When the ball went "out of play", for being caught in the goalkeeper's leg guards or in some outer part of the goal cage, the face-off will be conducted in one of the rear corners of the penalty area.
- 2.3.3 When the ball touches the ceiling, the face-off - *as established in paragraph 6.3 of Article 22 of these Rules* - will be conducted on the centre spot of the rink.
- 2.3.4 When stoppages occur when the ball is inside the penalty area or between the extension of the goal-line and the end boards of the rink, the face-off will be conducted in one of the corners of the penalty area, more specifically in the corner nearest to the place where the ball was at the moment of stoppage.

3. DAMAGE OR DEFECT OCCURRING DURING THE GAME

- 3.1 If interruptions occur during the game - *because of power failure, deficiencies on the rink itself, or because the rink becomes wet and slippery* - the MAIN REFEREES may allow a supplementary tolerance of sixty (60) minutes maximum, to solve the problems and resume the game.
- 3.2 The supplementary tolerance time mentioned above is the total time available to the MAIN REFEREES to interrupt the game to attempt to solve all these problems during a game.
- 3.3 When all sixty (60) minutes established in paragraph 3.1 of this Article expired, without the resolution of the problems, the MAIN REFEREES will end the game and inform the team captains of her/his decision, reporting all the facts on the official MATCH REPORT.

4. INJURED PLAYERS ON THE RINK

- 4.1 When a player or a goalkeeper is injured and falls inanimate on the floor, the MAIN REFEREES must stop the game immediately, and allow the DOCTOR and/or the MASSEUR to enter the rink to give the necessary assistance (*even if they have been expelled from the game*).
- 4.1.1 While a player is being assisted on the rink, the MAIN REFEREES must allow the other players (*including the goalkeepers*) to gather together near their reserve bench.
- 4.1.2 Except when no substitutes are available, a goalkeeper or player who receives assistance on the rink will be compulsorily replaced, considering that:
- The return to the rink of the goalkeeper or the player assisted on the rink is only allowed after the match has been resumed.
 - If, by disciplinary sanction or injury, there is no goalkeeper available, his substitution is assured by a rink player, pursuant to paragraph 5.1 of Article 20 of these Rules.
- 4.2 **Only the MAIN REFEREES can decide whether or not a goalkeeper or a rink-player has to be assisted on the rink. Consequently:**
- 4.2.1 If the DOCTOR and/or the MASSEUR (*or NURSE or PHYSIOTHERAPIST*) enters the rink without the prior authorization of the MAIN REFEREES, they will have to sanction them with a verbal warning, in accordance with the provisions of paragraph 3 of Article 30 of these Rules.



- 4.2.2 If there is recidivism in a verbal warning, a RED CARD will have to be shown to the offenders, expelling them from the match.
- 4.2.3 When the MAIN REFEREES demand the entrance in the rink of the DOCTOR and/or of the MASSEUR (or NURSE or PHYSIOTHERAPIST) and they end up not attending the injured player or goalkeeper, her/his substitution is likewise obligatory.
- 4.3 To resume the match, the MAIN REFEREES will order - depending on the place where the ball was at the time of the match interruption - the execution of:
- 4.3.1 An INDIRECT FREE HIT, in favour of the team that had possession of the ball when the interruption occurred;
- 4.3.2 A FACE-OFF, if there are doubts about the team that had possession of the ball.
- 5. ACTIONS IN WHICH AN ATTACKING PLAYER SEEKS TO BENEFIT FROM A FOUL IN AN ILLEGITIMATE WAY**
- 5.1 The MAIN REFEREES must clearly assess the situations that can produce behaviours that are ethically and sportingly reprehensible, when some players try to deceive the MAIN REFEREES and look for - in an illegitimate way - the benefit of a fault that, in reality, does not is, situations that occur more frequently in specific game actions, in particular:
- 5.1.1 Player who - having possession of the ball, inside the goal area of the opponent team - tries to be considered as fouls some game actions in which - for example - decides to renounce the attack of the goal, opting for directing the ball to:
- a) the body or protections of the goalkeeper who temporarily lost her/his stick;
- b) the body of a defending player who was lying on the rink.
- 5.1.2 Player or goalkeeper who tries to deceive the referees, pretending to have suffered a technical or disciplinary fault, trying to collect, illegitimately, a benefit for his team.
- 5.2 In the analysis of the game situations identical to those exemplified in the previous points, the MAIN REFEREES must interrupt the game immediately, deciding the following:
- 5.2.1 If this is the first time that the infringing player or goalkeeper incurs this type of infraction, the MAIN REFEREES will have to ensure:
- a) The verbal warning of the offender, as established in paragraph 3 of Article 30 of these Rules;
- b) To sanction with a TEAM FAULT, her/his reprehensible behaviour; and
- c) To restart the match with an INDIRECT FREE HIT (or with a DIRECT FREE HIT), having in mind what is established in the paragraph 3.1 of Article 31 of these Rules.
- 5.2.2 If the offending player or goalkeeper had already been verbally warned - in accordance with the provisions of paragraph 3 of Article 30 - a BLUE CARD will have to be displayed, implying - for her/him and her/his team - the additional sanctions provided in paragraph 2 of Article 32 of these Rules.
- 6. TEAM WITH 6 (OR MORE) PLAYERS ON THE RINK WHEN THE MATCH IS INACTIVE**
- 6.1 A team may have 6 (six) or more players on the rink during a break from the match, either because of a time-out, either for a goal, or for an injury to an athlete or any another reason.
- 6.2 In all these situations, the Main Referees cannot order the restart of the match, considering that it is their obligation to do so after fulfilling the applicable regulations. Consequently, they will have to order the exit of the rink to one (or more) players of the team in question, so that the match can restart.
- 7. UTILIZATION OF EQUIPMENT AND/OR PROTECTIONS NOT ALLOWED BY THE TECHNICAL REGULATION**
- Whenever the MAIN REFEREES verify that any player - and in particular the goalkeepers - is trying to use in the match any equipment and/or protections that are not in compliance with the Rink-Hockey Technical Regulation, the following procedures must be ensured:
- 7.1 To inform the offender - together with her/his team Delegate - that she/he must leave the rink immediately and cannot participate in the match if the irregularities in question were not removed.
- 7.2 If the offender wants to participate in the match, she/he must contact the AUXILIARY REFEREE in order to review the changes in her/his equipment and protections and to obtain permission to participate in the match.
- 7.3 Once is confirmed by the AUXILIARY REFEREE the conformity of the equipment and protections to be used by the offender in question, she/he will be authorised to go to the team "reserve bench", being ready to participate in the match.



CHAPTER VII - FOULS AND THEIR PUNISHMENT - "ADVANTAGE LAW"

ARTICLE 26- TYPOLOGY OF FOULS AND INFRACTIONS - "ADVANTAGE LAW"

1. According to their **NATURE**, the rink-hockey infractions and fouls can be divided as follow:
 - 1.1 Infractions and **technical** fouls
 - 1.2 Infractions and **disciplinary** fouls
2. As regards the infractions and disciplinary fouls, the following subdivisions must also be distinguished:
 - 2.1 In terms of their **SEVERITY**:
 - 2.1.1 Minor fouls
 - 2.1.2 Team fouls
 - 2.1.3 Serious fouls = Blue card fouls
 - 2.1.4 Major fouls = Red card fouls
 - 2.2 In terms of their **FORM**:
 - 2.2.1 Verbal fouls
 - 2.2.2 Contact fouls
 - 2.3 In terms of their **MOMENT**:
 - 2.3.1 Fouls committed while the game is in progress
 - 2.3.2 Fouls committed when the game is stopped
 - 2.4 In terms of their **ORIGIN**:
 - 2.4.1 Fouls on the rink
 - 2.4.2 Fouls on the reserve bench
3. **INFRACTIONS AND "ADVANTAGE LAW"**
 - 3.1 The Main Referees must always interrupt the game to signal a foul, except in situations when they have to apply the "**ADVANTAGE LAW**" - *as set out hereafter* - and let continue the play, in order to guarantee that the offending team does not benefit from the foul itself committed.
 - 3.2 If an imminent goal situation occurs, the Main Referees must allow the "**ADVANTAGE LAW**", and, immediately upon conclusion of the shot, proceed as follows:
 - 3.2.1 **WHEN NO GOAL IS SCORED**, stop the game immediately and proceed as indicated in paragraph 3.5.1 a) and b) of this Article.
 - 3.2.2 **WHEN A GOAL IS SCORED**, the MAIN REFEREES must validate it and, afterwards, will be applied- *if this is the case* -the disciplinary punishment to the offenders and their team, restarting the game with a centre pass corresponding to the goal scored.
 - 3.3 When there is no imminent goal situation, the Main Referees will only grant the "**ADVANTAGE LAW**" when the team that suffered a team foul may benefit from a favourable counter-attack situation, i.e., when one of the following situations occurs:
 - 3.3.1 One or two players from the team that suffered the foul proceed with the ball to the opponent's goal cage, having - *besides the Goalkeeper* -only one opponent, or even none, in their way.
 - 3.3.2 Three of its players, one of them with the ball, proceed to the opponent's goal cage, having - *besides the goalkeeper* -the opposition from two, one or no opponents.
 - 3.4 Whenever the MAIN REFEREES decide to apply the "**ADVANTAGE LAW**" - *in consideration of paragraph 3.3 of this Article*-not whistling an infraction, they will have to indicate to the AUXILIARY REFEREE - *without interrupting the match* -the annotation of a TEAM FAULT that has been committed by the offending player.
 - 3.5 Except for paragraph 3.2 of this Article, the "**ADVANTAGE LAW**" will not be applied by the Main Referees - *who must interrupt the game and immediately signal the foul* - in one of the following circumstances:
 - 3.5.1 **WHEN A SERIOUS OR MAJOR FOUL WAS COMMITTED**, the MAIN REFEREES must adopt the following additional procedures:
 - a) To sign the **disciplinary sanction of the foul or infraction**, both to the offender (*blue or red card, accordingly*) and to the offender's team ("*period in inferiority*").
 - b) To sign the **technical punishment of the offender's team**, with a direct free hit or a penalty shot, in function of the place where the foul was committed.



3.5.2 WHEN A TEAM FOUL WAS COMMITTED that - *by itself and in consideration of paragraph 3.1 of Article 31 of these Rules* -determines a **direct free hit** against the offender's team.

4. FOULS COMMITTED WITH THE STICK AGAINST THE OPPONENT'S STICK

4.1 The Main Referees must be able to discriminate and correctly evaluate all situations of play, namely when there are actions that may be considered faulty and, among these, the situations in which the "ADVANTAGE LAW" may be applied, taking in consideration the above Articles of the present chapter.

4.2 In the specific case of faulty actions committed with the stick, the Main Referees must be able to assess - *in order to avoid unnecessary interruptions in the game* -the situations in which, effectively, a foul with a stick may not go unpunished, as in the following examples:

4.2.1 When a player slightly "touches" an opponent's stick, the Main Referees will allow the game to go on normally, without signalling a foul.

4.2.2 When a player uses her/his stick to "hit" repeatedly and/or vehemently an opponent's stick, the Main Referees will ensure the following procedures:

a) Immediately stop the game and signal a team foul and then order an indirect free hit against the offender's team, as established in paragraph 5.4 of Article 31 of these Rules; or

b) Apply the "ADVANTAGE LAW" - *if this is the case, in attention of paragraphs 3.3 and 3.4 of this Article* -and to sign the annotation of a "team fault" to the AUXILIAR REFEREE.

ARTICLE 27-SANCTIONING OF THE FOULS -GENERAL RULES

1. All fouls and violations of the Rules of the Game must have, from the Main Referees, the appropriated sanctions, ensuring that their actions and interventions at the game, will be done accordingly with the two following main points:

1.1 The disciplinary sanction of the offender, which may involve:

1.1.1 **A VERBAL WARNING**, considering the following two differentiations:

a) **VERBAL WARNINGS IN SPECIFIC SITUATIONS**, in accordance with what is established in paragraph 2 of Article 30 of these Rules;

b) **VERBAL WARNINGS IN GENERAL SITUATIONS**, in accordance with what is established in paragraph 3 of Article 30 of these Rules;

1.1.2 **TEMPORARY SUSPENSION OF THE GAME**(*display of a blue card*),as provided in Article 32 of these Rules

1.1.3 **DEFINITIVE EXPULSION FROM THE GAME**(*display of a red card*), as provided in Article 33 of these Rules.

1.2 The sanction in technical and disciplinary terms of the team of the offender, which may involve:

1.2.1 Concerning the **TECHNICAL SANCTION OF THE OFFENDER'S TEAM**:

a) The execution of an **indirect free hit**, as provided in Article 34 of these Rules.

b) The execution of a **penalty shot** or a **direct free hit**, as provided in Article 35 of these Rules.

1.2.2 Concerning the **DISCIPLINARY SANCTION OF THE OFFENDER'S TEAM**, which will have to play with only four (4)players (*plays a "period in inferiority", with one player less in the rink*),as provided in paragraph 1.2 of Article 18 of these Rules.

2. Except situations in which the Main Referees must apply the "ADVANTAGE LAW", all fouls committed during the game must be penalised according with their gravity, bearing in mind that a foul will be considered as more serious as more it contributes to prevent a goal from being scored.

3. ROUGH AND INCORRECT PLAY

3.1 In Rink- Hockey, the hard and the incorrect playing is not allowed, and the Main Referees must punish all the irregular behaviours, in particular:

a) Pressing an opponent against the goal cage or the rink boards;

b) Charging, pushing and deliberately obstructing an opponent;

c) Fencing or hitting opponent players with the stick or grabbing them by some part of their equipment or body;

d) Fighting, punching, kicking or any other kind of aggressions.

3.2 Except for the goalkeeper inside her/his penalty area, no other player is allowed to grab the goal cage while playing the ball.

3.3 Hitting or hooking an opponent with the stick is a particularly violent and dangerous act that the MAIN REFEREES will severely punish, both technically and disciplinarily.



4. PLACE OF THE FOULS

With the exception of the disposals of paragraph 5 of this Article, the place of the foul is defined in function of the "place where the foul is committed", having in mind that - *when, as the result of a shot to the cage, the ball was lifted over 1, 5 metres* - the place of the foul coincides with the "place where the action started", i.e., the place where the ball was struck by the stick of the attacking player.

5. FOULS SIGNALLED IN THE DEFENSIVE ZONE OF THE TEAM BENEFITING FROM THE FOUL

When a team benefits from an indirect free hit -*for a foul that was committed anywhere in the whole of their defensive zone* -the ball may be put in play immediately - *if the ball is completely still* - without being necessary to respect the exact location where the foul was committed, nor take it to one of the corners of the penalty area.

6. ADDITIONAL OFFENCES WITH THE GAME STOPPED AFTER THE SANCTIONING OF A PREVIOUS FAULT

When- *with the match interrupted, one or more representatives of a team were sanctioned with a blue card and/or with a red card* -another offence is committed by any of the representatives of the same team - *regardless of whether or not it was committed by the same infractors that had initially been sanctioned* -the MAIN REFEREES will have to ensure the procedures established in the following paragraphs.

6.1 DISCIPLINARY SANCTION OF THE OFFENDERS

6.1.1 If a **MINOR MISCONDUCT** occurs - *including an incorrect behaviour or an inconvenient attitude* -the MAIN REFEREES must ensure one of the following disciplinary procedures:

- a) In the case of the offender's first disciplinary infraction, a **VERBAL WARNING** will have to be made - *in a public and transparent manner* -without any other consequence for her/him or her/his team.
- b) If the offending player is a repeated offender in a disciplinary infraction punishable by a verbal warning, the MAIN REFEREES will always have to show her/him a **BLUE CARD**, then assuring the additional procedures established in paragraph 2.1 of Article 32 of these Rules.

6.1.2 If a **SERIOUS INFRACTION** occurs, the MAIN REFEREES will have to show a **BLUE CARD** to the offender, assuring the additional procedures established in paragraph 2.1 of Article 32 of these Rules.

6.1.3 If a **VERY SERIOUS INFRACTION** occurs, the MAIN REFEREES will have to show a **RED CARD** to the offender, assuring the additional procedures established in paragraph 2.1 of Article 33 of these Rules.

6.1.4 Bearing in mind that this will be a new infraction of a player of the same team, the team must be always sanctioned with two (2) different "periods of inferiority", according with the Article 18 of these Rules.

6.2 DISCIPLINARY SANCTION OF THE OFFENDERS' TEAM - PLAYING IN "INFERIORITY"

6.2.1 If there is only one of the offenses mentioned in paragraphs 6.1.1 b), 6.1.2 or 6.1.3 of this Article, the offender's team will always have to be sanctioned with one (1)"period in inferiority"

6.2.2 If two or more of the offenses mentioned in paragraphs 6.1.1 b), 6.1.2 or 6.1.3 of this Article, the offender's team must be sanctioned with two (2) or more different "periods of inferiority".

6.2.3 - In any of the situations referred to in paragraphs 6.2.1 and 6.2.2 of this Article the MAIN REFEREES will have to ensure the different procedures established in Article 18 of these Rules.

6.3 TECHNICAL SANCTION OF THE TEAM OF THE OFFENDORS

6.3.1 Safeguarding the provisions about the disciplinary sanctioning of the team of the offenders ("*period in inferiority*"),**the infringements practiced when the game was stopped or interrupted will not have any consequences regarding the technical punishment of the team of the offender** and the procedures to restart the game will always be carried out in accordance with the provisions of the following paragraph.

6.3.2 The Main Referees will restart the game taking into consideration the infringements that lead to the game interruption, that is:

- a) In the case of fouls or infringements committed at the same time or at the same moment of the game, the restart of the game will have to be carried out in accordance with the provisions of paragraph 7 of this Article.
- b) In all the other situations, the restart of the game will have to be carried out with a direct free hit or with a penalty against the team of the offenders, after taking into consideration the rink place where the serious or major foul was committed.



6.4 In conformity with the established in paragraph 1.2 of Article 18, when match is restarted, each of the teams will have a minimum of four (4) players on the rink.

7. INFRINGEMENTS COMMITTED SIMULTANEOUSLY OR WITHIN THE SAME MOMENT OF AN ACTIVE GAME

7.1 FOULS OF THE SAME SERIOUSNESS PRACTICED BY REPRESENTATIVES OF EACH TEAM

7.1.1 When two offenders - *one from each team* - are responsible, in the same moment of a match, for **infringements of the same severity**, the teams and the offenders will be subjected to similar sanctions, with the restart of the match being ensured by the MAIN REFEREES as established in the next paragraph.

7.1.2 To restart the game, the following two alternatives have to be considered:

- a) **Execution of a face-off**, provided that one of the following situations is verified:
 - None of the teams had to be technically sanctioned with the execution of a direct free hit or penalty;
 - Each team had to be technically sanctioned with the execution of a direct free hit, situation that it is not feasible, implying that the two direct free hits are cancelled.
- b) **Execution of a direct free hit**, a situation that can only occur when both teams were sanctioned with a “team fault” and only one of them has to be sanctioned in this way, having in mind the number of team fouls it had accumulated, in accordance with what is established in paragraph 3.1 of Article 31 of these Rules.

7.2 FOULS OF DIFFERENT SEVERITY PRACTICED BY REPRESENTATIVES OF EACH TEAM

When two offenders - *one from each team* - are responsible, in the same moment of a match, for **infringements of different severity**- *which imply different disciplinary sanctions* - the MAIN REFEREES have to ensure that the restart of the game must always be done with the execution of the technical sanction that corresponds to the most serious fault, taking into consideration the following principles and procedures:

7.2.1 **The first criteria that must be considered is the level of gravity of each one of the infringements**, and not the technical sanction that is related with each infringement.

7.2.2 **Consequently**, the team whose player is responsible for the most serious infringement is always the team that must be technical sanctioned by the MAIN REFEREES, as it is exemplified in the next paragraph of this Article.

7.3. EXAMPLES OF THE PROCEDURES TO BE USED - SIMULTANEOUS INFRINGEMENTS OF THE TWO TEAMS

The single criteria that must be considered by the MAIN REFEREES is the “seriousness” of each one of the infringements (*and not the way those infringements must be technically sanctioned*), taking into consideration the following two examples.

7.3.1 A player of team “A” was sanctioned with a “red card”. A player of team “B” was sanctioned with a “blue card”. Both teams are disciplinary sanctioned with one “period in inferiority” and “technically sanctioned” with a “direct free hit”.

Consequently- *and taking into consideration that the player of team “A” was responsible for an infringement whose gravity is higher than the infringement committed by the player of team “B”*- the MAIN REFEREES will have to restart the match with the execution of a “direct free hit” to be awarded to the Team “B”.

7.3.2 A player of team “A” is sanctioned with a “blue card”, implying that her/his team is disciplinary sanctioned with one “period in inferiority” and “technically sanctioned” with a “direct free hit”. A player of team “B” is sanctioned with a “team fault”- *which was the tenth accumulated team fault*-implying that her/his team must be “technically sanctioned” with a “direct free hit”.

Consequently- *and taking into consideration that the player of team “A” was responsible for an infringement whose gravity is higher than the infringement committed by the player of team “B”*- the MAIN REFEREES will have to consider that

- a) **Team “A”** must be disciplinary sanctioned with a “period in inferiority” and technically sanctioned - *in the restarting of the match* -with a “direct free hit”, taking into consideration that its player has committed the fault of higher gravity.
- b) **Team “B”** must be awarded with the execution of a direct free hit, implying that the “team fault” of its player must be cancelled (*team “B” will stay with 9 accumulated team fouls*).



8. FOULS OR INFRACTIONS COMMITTED FROM A DISTANCE ON OPPONENTS ON THE RINK

- 8.1 In the case of fouls committed from a distance - *throwing of stick, gloves, mask, etc. and when the ball is in play* - the “ADVANTAGE LAW” must only be granted by the MAIN REFEREES if there is an eminent goal situation.
- 8.2 If a goal occurs, the MAIN REFEREES will have to validate it, then securing the disciplinary sanction of the offender and his team and resuming the match with the corresponding “CENTRE PASS”
- 8.3 With regard to the offender, the MAIN REFEREES shall ensure the following disciplinary action:
- 8.3.1 If the offender is identified by the MAIN REFEREES, it must be displayed:
- a) a red card- and corresponding penalties for the offender and his club, in accordance with paragraph 2 of Article 33-if the ball is intercepted and/or if any of the participants in the match are reached (*Main Referees or players on the rink of any of the teams*);or
- b) a blue card- and corresponding penalties for the offender and his club, in accordance with paragraph 2 of Article 32-if any of the participants in the match are not reached.
- 8.3.2 If the offender is not identified, the MAIN REFEREES will have to ensure the procedures set out in paragraph 2.2 of Article 28 of these Rules.
- 8.4. With regard to the offender's team, the MAIN REFEREES must ensure the following sanctions:
- 8.4.1 To play a "period in inferiority", which is the disciplinary sanction established in the Article 18 of these Rules; and
- 8.4.2 If a goal has not been obtained, there is also place for a technical sanction and a "direct free hit" will be executed by the team that had suffered the fault in question.

ARTICLE 28 - FOULS COMMITTED OUTSIDE OF THE RINK

1. FOULS COMMITTED OUTSIDE THE RINK- DEFINITION

The team representatives who are in the reserve bench- *players, delegates and technical staff* -must be punished for the practice of any serious or very serious fouls, namely the following:

- 1.1 Throwing a stick or any other object onto the rink;
- 1.2 Protesting or ostensive disagreeing with the Main Referees' decisions;
- 1.3 Insulting, threatening or aggressing any agent in the game (*Main Referees, members of the Official Table, members of the opposite or own team, public*).
- 1.4 While play is in progress, entering the rink or, by any other means, trying to interfere with the Main Referees' or players' action on the rink.
- 1.5 Flagrant unfair conduct and lack of sportsmanship.
- 1.6 Manipulation of the game's clock with bad intentions, when controlled by a delegate of one of the teams in play.

2. PUNISHMENT OF FOULS COMMITTED OUTSIDE THE RINK

2.1 ESTABLISHED SANCTIONS FOR THE OFFENDERS IDENTIFIED BY THE MAIN REFEREES

- 2.1.1 To the PLAYERS and to the MAIN COACH must be shown- *depending on the seriousness of the fault*-a BLUE CARD or a RED CARD, complying with the corresponding sanction, safeguarding the disposition in the following point.
- 2.1.2 Safeguarding the provisions of paragraph 2.1.4 of Article 32 of these Rules, if a BLUE CARD is shown to the MAIN COACH, she/he is not suspended from the match, but her/his team must play a “PERIDO IN INFERIORITY”, as it is established in Article 18 of these Rules.
- 2.1.2 To the other team representatives - *DELEGATES, ASSISTANT COACH and OTHER STAFF MEMBERS*-will be shown a RED CARD, who must be expelled from the “reserve bench”.

2.2 ESTABLISHED SANCTIONS FOR THE OFFENDERS NOT IDENTIFIED BY THE MAIN REFEREES

- 2.2.1 Safeguarding what is established in paragraph 2.2.3 of this Article, at the first and second non-identified offence, the MAIN COACH will be sanctioned with a blue card, but not suspended.
- 2.2.2 After being sanctioned with a third blue card - *as a result of accumulation of cards, for similar infractions or not* -the MAIN COACH will be sanctioned with red card and expelled from the reserve bench for the remainder of the match.
- 2.2.3 When the MAIN COACH has been expelled, the Main Referees will show a red card to the team official delegate or, if also absent, to the player on the rink who acts as the team captain.



2.3. ESTABLISHED SANCTIONS FOR THE TEAM OF THE OFFENDERS

- 2.3.1 **DISCIPLINARY SANCTION:** To play a “PERIOD IN INFERIORITY”, as established in Article 18 of these Rules.
- 2.3.2 **TECHNICAL SANCTION:** To suffer the execution of a **DIRECT FREE HIT**, except if the infraction had happened when the match was not active, situation in which there is no place for a technical sanction.

ARTICLE 29 - TECHNICAL FOULS

1. Technical fouls include all infractions that were committed on the rink that are essentially related with the breaking of rules, procedures or technical gestures as specified in the Rules of the Game, as for example:
 - 1.1 Playing the ball when leaning on or clinging to the goal cage, except the goalkeeper when in her/his penalty area
 - 1.2 Remain in possession of the ball, stopped and with his back to the rink, in any of the corners of the rink or behind a goal cage
 - 1.3 Immobilise or keep the ball immobilised between the boards and the skates or between the fence and the stick
 - 1.4 Committing a foul when executing a penalty or direct free hit (*simulating or moving the ball after the 5 seconds allowed*)
 - 1.5 Lifting the ball above legally allowed height, except in the case of the goalkeeper- *when she/he is inside her/his penalty area* -and regardless of that action being a result of defending her/his cage.
 - 1.6 Committing a foul during a face-off (*moving the ball before the referee whistles, provoking the opponent to commit a foul, etc.*).
 - 1.7 Exceeding the time allowed for keeping the ball in one’s defensive zone (*ten or five seconds*)
 - 1.8 Irregularly preventing a goal from being scored (*intercepting the ball with hand or foot*)
 - 1.9 Intentionally kicking the ball with any of the skates.
 - 1.10 Grab or hold the ball with any of the hands
 - 1.11 Intentional action of goalkeepers - *grab the ball, lie down on top of it, hold it between the legs or with sleeves* - not allowing the ball to be played
 - 1.12 Play the ball off the rink.
 - 1.13 Shouting or whistling to trick the opponent who carries the ball.
 - 1.14 Hold the stick above shoulder height, so as to put in danger the physical integrity of another player, whether an opponent or a team mate.
 - 1.15 Cut or play the ball irregularly with the stick - *such as, cut or chop the ball with the acute edge of the blade* - except in the case of a goalkeeper - *when inside her/his penalty area* -and regardless if this action resulted in a defence or not.
 - 1.16 Entering or standing still in the opponent’s goalkeeper’s protection area, while not in possession of the ball.
2. Sanctions for technical fouls are awarded at the place where the foul was committed. They involve no disciplinary sanctions whatsoever
 - 2.1 With the exception of the proceedings established in paragraph 2.1 of Article 35 of these Rules, if the offending player is inside her/his penalty area, the Main Referees will stop the game immediately and sign a **penalty shot** against the offender’s team.
 - 2.2 In all other situations - *if the “advantage rule” is not applicable* -the Main Referees will stop the game immediately and sign an **indirect free hit** against the offender’s team, as established in paragraph 2 of Article 34 of these Rules.



ARTICLE 30-VERBAL WARNINGS

1. Any VERBAL WARNING - *whether of players, of goalkeepers or of other team representatives* -will have to be secured by the MAIN REFEREES in a public and transparent way, in a position near of the offender - *forcing the latter, if necessary, to stand up* -and using gesticulating signs indicating that, being the first infraction, this cannot be repeated.

1.1 The MAIN REFEREES shall record all verbal warnings made during a match, which shall also be recorded by the AUXILIARY REFEREE for inclusion in the OFFICIAL MATCH REPORT.

1.2 The AUXILIARY REFEREE shall also ensure that all VERBAL WARNINGS made by the MAIN REFEREES are recorded in the OFFICIAL MATCH REPORT.

2. SANCTIONABLE INFRINGEMENTS WITH VERBAL WARNING IN SPECIFIC SITUATIONS

It will be considered as **SPECIFIC VERBAL WARNINGS** the specific infringements that can occur during the execution of a PENALTY SHOT or of a DIRECT FREE HIT. These specific verbal warnings must be ensured by the MAIN REFEREES when one of the following infringements occur:

2.1 A player who- *is placed in the goal area of the team benefiting from the foul, at the time of the execution of a penalty shot or a direct free hit* -moves in the direction of the ball, before the has impacted, determining by MAIN REFEREES the procedures established in paragraph 8 of Article 35 of these Rules.

2.2 A goalkeeper who- *at the time of defending a penalty shot or a direct free hit*- moves before the playing player has impacted the ball, determining the procedures by the MAIN REFEREES that are established in paragraph 7.3 of Article 35 of these Rules.

2.3 Player who initiates the execution of a penalty shot or a direct free hit without having received the authorization signal from the MAIN REFEREE who is responsible for controlling the execution, determining the procedures established in paragraph 9.6 of Article 35 of these Rules.

3. SANCTIONABLE INFRACTIONS WITH VERBAL WARNING IN GENERAL SITUATIONS

3.1 In general situations, the MAIN REFEREES will have to sanction with a VERBAL WARNING an infractor that is responsible for one of the following infringements:

3.1.1 A player or goalkeeper who simulates an injury or who pretends to have suffered an injury by an opponent.

3.1.2 A player or goalkeeper who, without prior authorization of the MAIN REFEREES, enters or exits the rink by jumping the fence, either when the match is active or when the match is stopped.

3.1.3 A Doctor and/or Masseur who enters the rink to assist a player or a goalkeeper, without the prior authorization of the MAIN REFEREES.

3.1.4 A goalkeeper who- *without the proper and prior authorization of the MAIN REFEREES*-goes to the "reserve bench", either to clean the visor, or for any other reason.

3.1.5 A player who was prepared to execute a penalty shot or a direct free hit and that- *without the proper and prior authorization of the MAIN REFEREES*-goes to the "reserve bench" and/or to any other place of the rink.

3.1.6 A player or goalkeeper who has an active intervention in the match when her/his equipment does not comply with the regulatory conditions, as provided in paragraph 2.1 of Article 22 of these Rules.

3.1.7 A player or goalkeeper who seeks, in an illegitimate way, to benefit from a foul, in accordance with the examples presented in paragraph 5 of Article 25 of these Rules.

3.1.8 A coach, a player or any other representative of a team that- *without using profanity and or insults* - manifests a public disagreement with a Refereeing decision.

3.2 When the same offender re-joins - *one or more times* - any of the infractions punishable by verbal warning- *either at the same moment of the match or at a later action* - the MAIN REFEREES must immediately ensure the exhibition of:

3.2.1 A **BLUE CARD**, when the offender infractor is the MAIN COACH, or a GOALKEEPER, or a PLAYER, implying the additional sanctions established in paragraph 2 of Article 32 of these Rules.

3.2.2 A **RED CARD**, when the offender infractor is ANOTHER TEAM REPRESENTATIVE (*not mentioned in in the previous paragraph 3.2.1 of this Article*), implying - *for the offender and for her/his team* -the additional penalties provided for in paragraph 2 of Article 33 of these Rules.



ARTICLE 31 - TEAM FOULS

1. the "TEAM FOULS" are also minor infringements, including in particular.
 - 1.1 WITH THE MATCH STOPPED, only the following two (2) infractions are included:
 - 1.1.1 Not respecting the regulatory distance in the execution of an indirect free hit.
 - 1.1.2 Move or hold the ball, delaying the execution of the free indirect against her/his team.
 - 1.2 WITH THE GAME ACTIVE AND IN ITS COURSE, which are examples of the following fouls:
 - 1.2.1 To perform an illegal blockade or an intentional obstruction of an adversary, pursuant to the provisions in paragraphs 4 and 5 of Article 24 of these Rules.
 - 1.2.2 The contact fouls practiced without violence and without serious physical consequences, such as grabbing or pushing an opponent or hitting the stick or the area of the shin guards.
 - 1.2.3 When an offender - *for the first time and and with the game in progress* - is responsible for any infraction that is punishable by a verbal warning (*general situations*), according with the provisions of paragraphs 3.1.1 and 3.1.2 of Article 30.
2. INFORMATION AND REGISTRATION OF THE ACCUMULATED TEAM FOULS BY EACH TEAM
 - 2.1 The MAIN REFEREES must indicate to the AUXILIARY REFEREE *in a visible manner and using specific signals* - all the TEAM FOULS occurring during the match.
 - 2.2 The AUXILIARY REFEREE has the responsibility - *in relation to both teams* - to control:
 - 2.2.1 The updated record of the accumulated number of "team fouls".
 - 2.2.2 The public information of the accumulated number of "team fouls recorded for each equipment
 - 2.3 The registration of the accumulated number of team fouls will be constantly updated, moving from the first to the second period of the match and also - *if it is the case* - from the end of the normal time of the match to the extra time.
3. ACCUMULATED TEAM FOULS DURING THE MATCH- SANCTIONS AND PROCEDURES
 - 3.1 As soon as a team accumulates ten (10) team fouls it will be technically sanctioned with a direct free hit as well as each time this team accumulates five (5) additional team fouls.
 - 3.2 As soon as a team accumulates nine (9) team fouls in the first part of the match - *or when it accumulates five (5) additional team fouls (total of 14, 19, etc.) in the next periods of the match* - the AUXILIARY REFEREE will place a sign on the OFFICIAL TABLE OF THE GAME- *or show an information card* - so that, when another team foul is committed, the MAIN REFEREES immediately sign a direct free hit, not allowing the "advantage law".
 - 3.3 In any case, whenever a team reaches the number of accumulated team fouls that entails the sanction of a direct free hit, the AUXILIARY REFEREE will give the corresponding warning to the MAIN REFEREES by means of a sound signal or whistle.
 - 3.4 When- *at the same that the Official Table of the Game indicates the end of a period of the match* - the MAIN REFEREES signal a team foul that determines the sanction of the offender's team with a DIRECT FREE HIT, this has always to be executed with a direct shot aimed at the adversary's goal, in conformity with the provisions of paragraph 4.4.1 of Article 35 of these Rules.
4. TEAM FOULS PRACTICED WHEN THE MATCH WAS INTERRUPTED
Except for paragraph 3.1 of this Article, the team fouls committed while the game is stopped or interrupted will not be subject to any other sanction, being only signalled by the MAIN REFEREES for the AUXILIARY REFEREE's records.
5. TEAM FOULS PRACTICED WHEN THE MATCH WAS ACTIVE
 - 5.1 Except for paragraph 3.1 of this Article, the normal punishment of the team fouls committed while the match is active depends only on the place of the rink where they are committed, as defined below.
 - 5.2 The MAIN REFEREES will have to immediately stop the match - *considering that the "advantage law" cannot be applied* - when a team foul has been indisputably contributed to prevent a flagrant situation of a possible goal, situation that has to be technically sanctioned with the execution of:
 - 5.2.1 A DIRECT FREE HIT, if the foul in question was committed outside the area of the offending team;
 - 5.2.2 A PENALTY SHOT, if the foul in question was in the goal area of the offender's team
 - 5.3 In any of the two situations mentioned in the previous paragraph, the team fouls in question may not be recorded in the corresponding register, nor shall there be any disciplinary sanction of the offender or of her/his team.



- 5.4 In all other situations, the team fouls that are practiced must be indicated to the AUXILIARY REFEREE for registration, and then be sanctioned by the MAIN REFEREES - *safeguarding the provisions of paragraph 3.1 of this Article* -with the execution of an **indirect free hit**, in favour of the opposing team, without any disciplinary sanction for the offender or her/his team

ARTICLE 32 - SERIOUS FOULS (BLUE CARD)

1. The “serious fouls” - which force MAIN REFEREES to show a BLUE CARD to the offender -comprise acts or dishonourable facts expressing insubordination, insults and/or offences, as well as fouls that endanger someone’s physical integrity causing to need medical assistance and/or resulting in temporary incapacity to continue in the game, as for instance:
 - 1.1 Coach, player or goalkeeper of a team that, in its bench, has an incorrect behaviour, in clear signal of public disagreement in respect to any decision of the MAIN REFEREES of the match and/or any of the members from the OFFICIAL TABLE OF THE GAME.
 - 1.2 Player or goalkeeper who, on the rink, protests with the MAIN REFEREES, manifesting public disagreement with their decisions (*by words, gestures, ostentatious head movements, etc.*)
 - 1.3 Player or goalkeeper who, in the course of the game, show an aggressive attitude with a member of the opponent team, or with a Referee, or any member of the Official Table of the Match, or with a teammate or with the public.
 - 1.4 Player or goalkeeper who intentionally moves one of the goal cages.
 - 1.5 Holding, pushing or carrying an opponent in a dangerous manner (*including clashes against boards or fences on the rink, knocking down the opponent, etc.*).
 - 1.6 Without using violence, strike an opponent outside the zones protected by shin guards (*trunk, hands, arms, legs or knees*).
 - 1.7 Slam an opponent, knocking him down.
 - 1.8 Hook, by means of the stick, the skate of an opposing player, even if it is done unintentionally and even if the player in question does not end up being knocked over.
 - 1.9 Hooking or hitting, from behind, the stick of an opponent Player thus preventing him from throwing the goal.
 - 1.10 To perform an irregular substitution, entering the rink- *with the game active and in progress* -before the leaving of a colleague.
2. Safeguarding what is established in paragraphs 6 and 7 of Article 27 of these Rules, the serious fouls committed by team members - *players and goalkeepers, delegates, technical team and assistants*- will be sanctioned as follows:
 - 2.1 **DISCIPLINARY SANCTION FOR THE OFFENDER**
 - 2.1.1 When the offender is a goal-keeper or a player, the MAIN REFEREES must show a blue card and send him/her off for a period of two (2) minutes, except for paragraph 2.1.4 of this Article.
 - 2.1.2 When the offender is another team member, the MAIN REFEREES will show her/him a **BLUE CARD**, having in mind that:
 - a) According to what is established in paragraph 2.1.2 of Article 28 of these Rules- and safeguarding the disposals in paragraph 2.1.4 of this Article the MAIN COACH will not be suspended from the game;
 - b) If the MAIN COACH infringement occurs under the conditions established in paragraph 6.3 of Article 17 of these Rules, her/his team will always be sanctioned with two different “periods in inferiority.
 - 2.1.3 When the offender is another team member, the Main Referees will show - *according to paragraph 2.1.3 of Article 28 of these Rules*- a **red card**, signifying her/his definitive expulsion and leaving the reserve bench.
 - 2.1.4 In case a **third blue card is shown, by accumulation**- *to a goalkeeper, to a rink player or to the team MAIN COACH* -the MAIN REFEREES will show the offender a **RED CARD** and expel her/him from the game.
 - 2.1.5 A player who serves a temporary suspension must take place on one of the seats placed next to the OFFICIAL TABLE OF THE GAME, near to his reserve bench. He may not re-enter the rink before serving his full suspension time.
 - 2.1.6 When, at the end of a period of the game, a player has not fully served his suspension, he will continue suspended at the restart of the game, until serving the remaining time.
 - 2.1.7 When a player’s temporary suspension time expires, he will be immediately warned by the AUXILIARY REFEREE and allowed to return to his team’s reserve bench.



2.2 DISCIPLINARY PENALIZATION AND TECHNICAL SANCTION OF THE OFFENDER'S TEAM

- 2.2.1 The team of the offenders will have to play a “period of inferiority”, according to the provisions of Article 18 of these Rules.
- 2.2.2 Safeguarding what is established in paragraph 2.2.3 below, the offender’s team will be sanctioned with a DIRECT FREE HIT, or a penalty shot, depending on the place where the foul was committed.
- 2.2.3 If the serious foul is committed when the game is not in progress - *either during an interval or during a stoppage in the game* -no technical sanction will be awarded.

ARTICLE 33- VERY SERIOUS FOULS (RED CARD)

1. The “very serious fouls” - *which force the MAIN REFEREES to show a RED CARD to the offender* -comprise very serious acts of indiscipline that may involve violence or major harm, or endanger the physical integrity of third parties, as for instance:
- 1.1 Assuming, towards any agent in the game - *public, Main Referees, members of the Official Table of the Game, players and other members of her/his own or of the opposite team* -which assumes one of the following behaviours:
- 1.1.1 Threats, insults, injurious words or obscene gestures;
- 1.1.2 Aggression or attempted aggression;
- 1.1.3 Reaction or attempted reaction to aggression, through aggressive and/or violent behaviour.
- 1.1.4 Any other violent or brutal acts.
- 1.1.5 A player or goalkeeper that is accomplishing a temporary suspension of the game and that has an incorrect behaviour, protesting and/or showing a public disagreement in respect to any of the MAIN REFEREES and/or to any of the members from the OFFICIAL TABLE OF THE GAME.
- 1.2 Threatening, pushing or trying to attack an opponent when play is not in progress (*stoppage, interval or end of the match*)
- 1.3 Rolling with the skates against an opponent, throwing him/her to the ground.
- 1.4 Violently hitting an opponent on parts of the body that are not protected with padding (*trunk, hands, arms, legs or knees*).
- 1.5 Intentionally hooking an opponent’s skate with the stick, making him hit the floor.
- 1.6 Throwing objects on the rink in the direction of the ball or against the Main Referees, the opponents or the team-mates.
- 1.7 Provoking the public with offensive gestures or expressions (*or considered as such*).
- 1.8 Practicing a new serious or major foul, when she/he was under a temporary suspension and the game had already restarted
- 1.9 A direct interference in any action of the match - *by an element of the team “reserve bench” (player, coach, delegate or other staff member)* - preventing the normal development of a play, either from the opposing team, or from her/his own team.
2. Major disciplinary fouls committed by team members - *Players, Goalkeepers, Delegates, Technical team and Assistants* - will be penalised as follows:
- 2.1 **DISCIPLINARY SANCTION FOR THE OFFENDER**
The MAIN REFEREES will show the offender a red card; expel her/him from the remainder of the game and forcing her/him to leave the reserve bench.
- 2.2 **DISCIPLINARY AND TECHNICAL SANCTIONS FOR THE OFFENDER’S TEAM**
- 2.2.1 The offender’s team will be penalised with a “PERIOD IN INFERIORITY” for a maximum period of 4 (*four*)minutes, according to Article 18 of these Rules.
- 2.2.2 Technically - *with the exception established in the next paragraph* -the offender’s team will be awarded a DIRECT FREE HIT or a PENALTY SHOT, depending on the place where the foul was committed.
- 2.2.3 If a VERY SERIOUS FOUL is committed when the game is not in progress - *either during an interval or during a stoppage in the game* - no technical sanction will be awarded.



CHAPTER VIII - TECHNICAL SANCTIONS OF THE TEAMS

ARTICLE 34 - INDIRECT FREE HIT

1. An **INDIRECT FREE HIT** will be signalled by the MAIN REFEREES to:
 - 1.1 Penalise technically minor fouls committed on the rink, as well as more serious fouls in specific situations of play.
 - 1.2 Restart the game - *after a stoppage called by the Main Referees without a foul having been committed* - benefiting the team in possession of the ball at the moment of stoppage.
2. **EXECUTING THE INDIRECT FREE HIT**
 - 2.1 In regular conditions, the indirect free hit must be taken with the ball stationary, put in motion with one single stroke, without the MAIN REFEREES having to whistle.
 - 2.1.1 When the player executing the hit asks the MAIN REFEREES for the opponents to position themselves at the regular distance of three(3) meters, the indirect free hit may not be taken before the referee whistles.
 - 2.1.2 When a foul is committed near the boards- *or when the ball went outside the rink* -the indirect free hit may be executed with the ball at a distance until seventy(70) centimetres from the boards in question.
 - 2.1.3 The players of the team benefiting from the foul may place themselves anywhere on the rink, except in the opponent goalkeeper's protection zone.
 - 2.1.4 The player executing the indirect free hit is not allowed to play the ball again until
 - a) the ball has been touched or played by another player; or
 - b) the ball has touched the outer part of one of the cages.
 - 2.1.5 When there is a delay in executing the indirect free hit, the MAIN REFEREES must whistle to order the game to start again immediately.
 - 2.2 The player executing the hit may ask the MAIN REFEREES that the opponent players be positioned at the regular distance of three(3) meters; in this situation the indirect free hit may only be executed after the Main Referees' whistle.
 - 2.2.1 if, before the whistle of the Referee, the ball is moved by the executant player, the team of the offender will be immediately sanctioned with indirect free-kick, to be executed in the same location.
 - 2.2.2 After the MAIN REFEREES whistle, the ball is in play and any player of the punished team may try to get possession of the ball and ensure the continuity of the game.
3. **PLACES FOR THE EXECUTION OF INDIRECT FREE HITS**

The place where an indirect free hit is taken will be determined by the kind of foul that was committed and the place where the foul was committed, as follows:

 - 3.1 In the case of fouls committed in the opponent's defensive zone, the indirect free hit will be taken in any place of the same zone, as it is specified in paragraph 5 of Article 27 of these Rules.
 - 3.2 **IN CASE THE BALL RISES OVER 1,50 METERS HIGH**, as a result of a movement of a player's stick who was "inside" her/his penalty area, the indirect free hit will be taken by the opposite team in one of the upper corners of that area.
 - 3.3 In the case of fouls committed behind the offender's own goal cage, the indirect free hit will be taken in the rear corner of the penalty area, nearest to the place of the foul.
 - 3.4 In the case of a player jumping the fence, the indirect free hit will be taken near the place of the foul:
 - 3.5 In the case the ball is retained in one's defensive zone longer than the time allowed, the indirect free hit is taken as specified in paragraph 3.2 of Article 15 of these Rules.
 - 3.6 In the case of any other fouls, the indirect free hit will be taken at the same place where the foul was committed.



4. GOAL SCORED FROM AN INDIRECT FREE HIT

- 4.1 A goal scored from an indirect free hit will be valid only when- *before it enters the goal cage* -the ball has been touched or played by any other player.
- 4.2 The goal will not be validated when the ball enters the cage directly, without having been touched by a stick or player. The game will restart with a face-off, to be executed in any of the lower corners of the respective penalty area.

ARTICLE 35 - DIRECT FREE HIT AND PENALTY SHOT

1. INFRINGEMENTS "OUTSIDE" THE GOAL CAGE AREA THAT ARE SANCTIONABLE WITH A DIRECT FREE HIT

- 1.1 The MAIN REFEREES must strictly sanction - *indicating the corresponding direct free hit* -all the serious and/or very serious fouls that - *with or without the ball present* - are practiced on opponents that are located "outside" the goal cage area of the infractor, taking into account that in the "area" in question are included the "lines" that delimit it, as established in paragraph 2.1 of Article 2 of the Technical Regulation(*which constitutes the Annex of these Rules*).
- 1.2 The MAIN REFEREES must also sanction with the execution of a direct free hit the technical fouls and/or the team fouls practiced "outside" de offender's goal cage area that prevent a possible goal from the opposing team.

2. INFRACTIONS COMMITTED IN THE GOAL CAGE AREA OF THE OFFENDERS

2.1 PLAYING ACTIONS NOT PUNISHED WITH THE EXECUTION OF A PENALTY SHOT

The following specific situations should not be sanctioned with the execution of a penalty:

- 2.1.1 When the ball rises 1.50 meters high, as a result of a movement of a player's stick that was "inside" of his goal area - *regardless of whether (or not) an infraction is practiced intentionally* -the MAIN REFEREES will sanction this infraction with an INDIRECT FREE HIT, executed by the opponent team in any of the upper corners of the goal area.
- 2.1.2 When the ball is stopped or deflected by an unintended or unintentional action - *a rebound in the body, or the skates or stick* -of a player that was "inside" of its goal cage area, situation is which, by itself, will not have to be sanctioned by the MAIN REFEREES.

2.2 PLAYING ACTIONS PUNISHED WITH THE EXECUTION OF A PENALTY SHOT

- 2.2.1 The MAIN REFEREES must strictly sanction - *indicating the corresponding penalty* -all serious and/or very serious fouls that - *with or without the ball present* -are practiced on opponents that are located "in the interior" of the goal cage area of the infringing player or goalkeeper, considering that in the "area" in question are included the "lines" that delimit it.
- 2.2.2 The MAIN REFEREES must also pay special attention and punish with equal zeal and rigor all other faults practiced "inside" the offender's goal area, in particular:
 - a) Infringement committed by a goalkeeper who does not allow the ball to be played, grasping it by hand, throwing itself on the ball or holding it between his legs or with his gloves.
 - b) Player or goalkeeper who illegally grabs, pulls, loads or blocks an opponent who - *without the ball being present* -moves to receive a pass from a partner or that is attempting to occupy a more favourable position next to the goal cage of the offending player.
 - c) Player or goalkeeper who, in defence of her/his goal cage, committed a foul -*regardless of having been done deliberately and intentionally* - contributed in an indisputable way to preventing the achievement of a goal by the opposing team.

3. PLACES FOR THE EXECUTION OF PENALTY SHOT OR THE EXECUTION OF A DIRECT FREE HIT

The execution of a penalty hit or of a direct free hit will have to be carried out in the half-rink of the sanctioned team in the marks specifically designated for such effect, namely:

- 3.1 In the case of the penalty shot, the mark in the upper line of delimitation of the goal cage area, which is located 5,40 meters from the centre of the goal cage line.
- 3.2 In the case of the direct free hit, the mark that is located 7,40 meters from the centre of the goal cage line.



4. GENERAL RULES TO BE CONSIDERED IN THE EXECUTION OF THE DIRECT FREE HIT

- 4.1 The execution of the direct free hit cannot be initiated after the expiration of the five (5)seconds that are granted for that purpose
- 4.2 The player who executes of the direct free hit has to choose between:
- 4.2.1 A standing position, next to the ball; or
- 4.2.2 A movement launched - *without stops or simulations* -from a maximum distance of three (3)meters of the corresponding execution mark.
- 4.3 In the execution of the direct free hit, no simulations can be done and, therefore, the player who performs is not allowed to:
- 4.3.1 To do a stop or non-uniform movement in the positioning of the stick to hit the ball
- 4.3.2 To perform - *prior to the impact of the stick on the ball* - a movement of his body or stick, attempting to deceive the opponent goalkeeper and causing him to engage a disciplinary sanction.
- 4.3.3 Do not execute the free kick in accordance with the provisions of paragraph 4.2 of this Article, not pulling or deflecting the ball into the direction of the opposing goal cage and choosing:
- a) to retain possession of the ball and endorse it (pass it) to a partner;
- b) to carry the ball behind the goal cage of the opponent team.
- 4.4 Safeguarding what is established in paragraph 6 of this Article, the player in charge of the execution of the direct free hit may opt- *from the corresponding mark located in the defensive zone of the sanctioned team* - for one of the following execution procedures:
- 4.4.1 To perform a direct shot and obligatorily directed to the opposing goal cage.
- 4.4.2 To carry the ball in the direction of the opposing goal cage, attempting to dribble the goalkeeper and/or afterwards carrying out a shot or deflection of the ball towards the goal cage in question.

5. GENERAL RULES TO BE CONSIDERED IN THE EXECUTION OF THE PENALTY SHOT

- 5.1 The execution of the penalty cannot be initiated after the expiration of the five (5)seconds that are granted for that purpose.
- 5.2 The player in charge of the execution of the penalty must always do so with a direct shot - *directed towards the goal of the opponent* - which must be executed in the standing position, next to the ball, from the corresponding mark.
- 5.3 The player in charge of the penalty execution cannot do any simulation and, besides, it is not allowed :
- 5.3.1 To stop or to make a non-uniform movement of the stick that hits the ball.
- 5.3.2 To perform - *prior to the impact of the stick on the ball* -a movement of the body or of the stick, trying to deceive the goalkeeper and adversely cause him to engage a disciplinary sanction.
- 5.3.3 To execute the penalty without accomplishing all the provisions established in paragraph 5.2 of this Article.
- 5.4 If there is no goal in the execution of the penalty shot- *after a goalkeeper defence or a rebound on the goal cage or on the fence of the rink*- and the ball is recovered by the executant player, it is allowed to carry it or to opt for another shot towards the opponent's goal cage.

6. EXECUTION OF A PENALTY SHOT OR OF A DIRECT FREE HIT SIGNALLED AT THE END OF THE PLAYING TIME

- 6.1 When - *at the exact moment the Official Table sounds the end of a period of the game* - a foul occurs that must be sanctioned with a penalty shot or direct free hit - *including, if it is the case, the situations in which is applicable the paragraph 3.1 of Article 31 of these Rules* - the MAIN REFEREES will ensure its execution - *according to the paragraphs 4 y 5 of this Article*-and taking in account the following restrictions:
- 6.1.1 As with the execution of the penalty shot, **the execution of the direct free hit must be carried out with a direct shot**, and simulations or transport of the ball are not allowed.
- 6.1.2 After the execution of the direct free or the penalty is not allowed any other action.
- 6.2 Depending on the result of the execution of the direct free hit or of the penalty shot at the end of the statutory time of play, the MAIN REFEREES will have to apply the following procedures:
- 6.2.1 **Except as provided in paragraphs 3.5 and 5.5 of Article 3 of these Rules**, if a valid goal is scored, the MAIN REFEREES must secure its formal recognition, ordering the subsequent "centre pass" and immediately whistling to sign the ending of the playing time in question.
- 6.2.2 If no goal is scored due to irregularities committed by the defending goalkeeper during the execution, the MAIN REFEREES shall order the repetition of the direct free hit or of the penalty shot.



- 6.2.3 If no goal is scored - *without the defending goalkeeper having committed any foul or irregularity* - the MAIN REFEREES will immediately whistle the ending of the playing time in question.

7. GENERAL RULES ABOUT THE GOALKEEPER DURING THE DEFENSE OF A DIRECT FREE HIT OR OF A PENALTY SHOT

7.1 COMPULSORY PRESENCE OF A GOALKEEPER IN THE DEFENSE OF THE GOAL CAGE

When a team is technically sanctioned with the execution of a direct free or a penalty is always mandatory the presence of a Goalkeeper in defence of the goal cage of the offending team.

- 7.1.1 If the goalkeeper has been replaced by a rink player - *in accordance with paragraph 5.2 of Article 20 of these Rules* - the execution of the direct free hit or of the penalty shot can only be performed after the substitution of a rink-player by a goalkeeper.
- 7.1.2 If - *due to an injury or to a disciplinary sanction* -there is no goalkeeper available, she/he will be replaced by a rink player, in accordance with the conditions established in paragraph 5.1 of Article 20 of these Rules.

7.2 RESTRICTIONS TO THE GOALKEEPER'S MOVEMENTS

When a penalty shot, or a direct free hit, is executed against her/his team, the goalkeeper must:

- 7.2.1 Stand on both skates, front axles (*breaks or wheels*)on the goal-line.
- 7.2.2 Hold her/his stick against her/his two skates, horizontally and parallel to the goal-line, and also the hand holding the stick does not lean on the cage or floor. Besides that, her/his free hand must remain static, and not in contact with goal cage or floor.



- 7.2.3 Not make any movement to defend her/his cage before the ball is being struck or touched by the player in charge of the penalty shot or of the direct free hit.

7.3 PUNISHMENT OF THE GOALKEEPER'S OFFENCES WHEN DEFENDING A DIRECT FREE HIT OR A PENALTY SHOT

When the goalkeeper moves before the player in charge of the penalty shot or of the direct free hit touches the ball, the following procedures must be followed:

- 7.3.1 At the goalkeeper's first offence, he will receive a VERBAL WARNING. The MAIN REFEREES will place themselves in front of the offender - *who must stand up* - and give him the "VERBAL WARNING" advising her/him to not repeat the same offence.
- 7.3.2 At the goalkeeper's second offence - *on occasion of the same penalty shot or direct free hit* -he will receive a BLUE CARD or - *if the second offence was committed during a penalty shot to untie the score* -a RED CARD.
- 7.3.3 In consideration of Article 18 of these Rules, the offending goalkeeper's team is punished with a "period of inferiority", except when the penalty shot is performed to untie the score.
- 7.3.4 If the first reserve goalkeeper was also suspended or expelled - *in consideration of paragraphs 7.3.1 and 7.3.2 of this Article* he must be replaced by a rink-player or by another goalkeeper (*who would be registered on the official MATCH REPORT*).
- 7.3.5 If a second reserve goalkeeper should also be suspended - *in consideration of paragraphs 7.3.1 and 7.3.2 of this Article* - the MAIN REFEREES will end the game and give detailed information on the official MATCH REPORT.



7.4 When a penalty or direct free hit is executed with a direct shot *-and simultaneously the Goalkeeper moves forward* - and a goal is scored, the MAIN REFEREES will have to apply the following procedures:

7.4.1 If one of the MAIN REFEREES had whistled to interrupt the match, the goal cannot be validated, and the goalkeeper must be sanctioned as established in paragraphs 7.3.1, 7.3.2 y 7.3.3 of this Article-. After that, the MAIN REFEREES must order the repetition of the penalty shot or of the direct free hit in question.

7.4.2 When there is no interruption of the match, MAIN REFEREES must grant the validation of the goal, after applying *- as provided in paragraphs 7.3.1, 7.3.2 y 7.3.3 of this Article*-the sanction of the offender goalkeeper.

8. INFRACTIONS OF PLAYERS WITHOUT INTERVENTION IN A PENALTY SHOT OR IN A DIRECT FREE HIT

8.1 Safeguarding what is established in paragraph 9.2 of this Article, the players who not have a direct intervention in the execution of a penalty or of a direct free hit- *and are positioned inside the goal area of the team that benefits from the foul* - may only leave or move from that place after the player in charge of the execution of the penalty shot or of the direct free hit has impacted or touched the ball.

8.2 When a violation of the above paragraph occurs- *except what is specifically provided in paragraph 8.3 of this Article* -- the MAIN REFEREES must ensure *- in conformity with paragraph 2of Article 30 of these Rules* -the following procedures:

8.2.1 In case it is the first foul committed by a player or a goalkeeper of one of the teams:

a) The offender must receive a verbal warning, being "informed" *- as well as the other players of her/his team* that repeating the foul will entail a blue card for the offender.

b) Then *- and except for the provisions established in paragraph 8.3.2 a) of this Article*- the penalty shot, or the direct free hit, will have to be repeated.

8.2.2 If, during the repetition of the same penalty shot or of the direct free hit, a new foul is committed- *either by the same player or by another player of the same team* -the MAIN REFEREES must ensure the following procedures:

a) The offender will immediately be awarded with a blue card, suspending her/him from the game, whose team will be sanctioned with a "period in inferiority", as established in Article 18 of these Rules.

b) Then, the penalty shot, or the direct free hit, will have to be repeated, except under the provisions established in paragraph 8.3.2 a) of this Article.

8.3 When the foul is committed after the execution of the penalty shot or of the direct free hit was initiated, the MAIN REFEREES will always wait for the outcome of the shot, ensuring afterwards the following procedures:

8.3.1 When a goal is scored, it must always be validated, ensuring afterwards *- but only when it is a repeating of the same foul* - the disciplinary sanction to the offender and her/his team, according to paragraph 8.2 of this Article.

8.3.2 When no goal is scored, the MAIN REFEREES will stop the game immediately, and ensure the following procedures:

a) When the foul is committed only by a player or players of the team that benefits from the penalty shot or from the direct free hit, the shot will not be repeated; the game will start again with an indirect free hit against the offending team, to be executed in one of the superior corners of the cage area.

b) When the foul is committed only by a player or players of the team sanctioned with a penalty shot or with the direct free hit *- or by players of both teams* -the shot will always be repeated, immediately after awarding the disciplinary sanction set out in paragraph 8.2 of this Article.

8.4 With regard to the DIRECT FREE HIT- *and being necessary to give attention to the method chosen by the player in charge of the hit* -the MAIN REFEREES will ensure the following procedures:

8.4.1 When the player in charge of the direct free hit chooses to shoot directly at the cage, the following must be applied:

a) When a goal is scored, the procedures established in paragraph 8.3.1 of this Article

b) When no goal is scored, the procedures established in paragraph 8.3.2 of this Article



8.4.2 When the player in charge of the execution of the direct free hit chooses to transport the ball, the game will be immediately stopped, and must be ensured the procedures that are established in paragraph 8.3.2 of this Article.

9. PROCEDURES OF MAIN REFEREES WHEN A PENALTY SHOT, OR A DIRECT FREE HIT IS TAKEN

9.1 The player executing the penalty shot or direct free hit is allowed maximum five (5)seconds, with the ball stationary, to start the execution of the hit - *time is controlled by one of the Main Referees by means of specific signs* -without the MAIN REFEREES having to whistle.

9.1.1 The execution of the penalty shot or of the direct free hit - *even when they are executed for the tiebreaker or the preventive tiebreaker of the match* -can be carried out by the **GOALKEEPER** of the team that benefits from the fault, in the condition that it is maintained with its protective shin guards, without using the helmet and gloves

9.2 The players who do not take part in the execution or defence of the penalty shot or of the direct free hit must place themselves on the other half of the rink - *inside the other penalty area* - and they are only allowed to move and actively participate in play when the ball was hited or touched.

9.2.1 **The players in question may not re-intervene in the match when the following events occur:**

- a) The execution of **penalties shots for the tiebreaker of the match**(*paragraph 2 of Article 3 of these Rules*);
- b) The execution of a **direct free hit** for a **pre-emptive playoff match**(*paragraph 3 of Article 3 of these Rules*);
- c) The execution of a **penalty shot** or of a **direct free hit** that is indicated at the end of the time of any of the periods of play.

9.3 One of the MAIN REFEREES places himself in front of the players mentioned in the paragraph 2.2 of this Article, at approximately one (1)meter distance, to control their position. When everything is in order, he will raise one arm vertically to inform the other Main Referee that he may give order to execute the penalty or direct free hit.

9.4 The other MAIN REFEREE places must be positioned at one of the lower corners of the penalty area of the sanctioned team, controlling the correct positioning of its goalkeeper and insuring - *after receiving the signal from the other Main Referee and without ever blowing a whistle* -the following procedures.

9.4.1 Raise one arm vertically, to indicate that the execution of the penalty or of the direct free hit may initiate.

9.4.2 The other arm- horizontally at waist height -makes a maximum of five(5)movements sideways- one movement for every second -to count the five (5)seconds time allowed to initiate the execution of the penalty shot or of the direct free hit.

9.4.3 The player executing the penalty shot or the direct free hit may only initiate the execution of the foul after the Referee ensures the procedure indicated in paragraph 9.4.1 of this Article, considering that:

- a) in the execution of a penalty, the ball has to be impacted directly to the goal;
- b) safeguarding what is established in paragraph 6 of this Article, in the execution of a direct free, the ball can be directly impacted to the goal or, alternatively, the ball can be touched and transported and then thrown to the gate.

9.4.4 The restart of the playing time shall be resumed at the time the ball is struck or played by the player in charge of the execution of the penalty shot or of the direct free hit

9.5 None of the teams is allowed to make a player enter the rink - *neither for a substitution, nor upon conclusion of the period of "playing in inferiority"* -from the moment the execution of the penalty shot or of the direct free hit is signalled until its conclusion.

9.5.1 In case of violation of the above, the MAIN REFEREES will not interrupt the game immediately - *they will wait for the outcome of the penalty or of the direct free hit* -and only afterwards proceed as established in next paragraphs.

9.5.2 **WHEN A GOAL IS SCORED, they must always validate it**, without prejudice of - *afterwards* - applying the disciplinary sanctions established in paragraphs 2.5.3 a) and b) of this Article.



- 9.5.3 NOT HAVING SCORED A GOAL, the game is interrupted immediately, and then the MAIN REFEREES will ensure the following procedures:
- a) A RED CARD must be shown to the player who entered the rink illegally, as well as to the MAIN COACH or - *in her/his absence and in this order* - to the Assistant Coach, or to one of the Delegates, or to the Captain on the rink;
 - b) Sanction the offender's team with two(2)different "periods in inferiority", according to Article 18 of these Rules;
 - c) If the foul was committed by a player of the team that suffered the sanction, the penalty shot or the direct free hit will be repeated;
 - d) If the foul was committed by a player of the team that was executing the penalty or the direct free hit, a direct free hit will be ordered against the offender's team.
- 9.6 When the player in charge of the execution of a penalty shot or of a direct free hit decides to start the execution before receiving the corresponding authorization signal from the Main Referees, this is clearly an irregular action - *which was practiced when the match was not active* - that will imply the following procedures by the MAIN REFEREES:
- 9.6.1 The offending player is verbally admonished, in the usual way, so that the public and the representatives of the two teams can be informed of the situation.
 - 9.6.2 After that, the execution of the penalty shot or of the direct free hit in question will have to be ordered.
 - 9.6.3 If the recidivism of the previous infraction by the same playing player occurs, that will involve the following additional procedures by the MAIN REFEREES:
 - a) The exhibition of a blue card to the offender player, who will be suspended from the game and will have to leave the track immediately;
 - b) The offender's team will be also sanctioned with the corresponding "period of inferiority", in accordance with what is established in Article 18 of these Rules.
 - c) The repetition of the execution of the penalty shot or of the direct free hit in question will be ordered, whose execution will be made by another player of the team of the offender.
- 9.7 Concerning what is established in paragraphs 4 and 5 of this Article, if the player in charge of the penalty shot or of the direct free hit commits a foul in its execution, the MAIN REFEREES will stop the game immediately and must sign a technical foul to the offender player, sanctioning his team with an indirect free hit, to be taken on the penalty or direct free hit spot.



CHAPTER IX-REFEREEING ERRORS - CLAIMS AND/OR PROTESTS

ARTICLE 36 - REFEREEING ERRORS - CORRECTION PROCEDURES

1. Safeguarding what is established in paragraph 3 of this Article, when it is perceived that - *by mistake of a Timekeeper, Assistant Referee or Main Referee* -an error was made in the direction of the game, the Main Referees must immediately stop the game - *if this should be the case* - and go to the OFFICIAL TABLE OF THE GAME in order to agree - *together with the Auxiliary Referee and/or the Timekeeper* -which are the correction procedures to be adopted.
 - 1.1. In any case, the Main Referees will only apply the correction procedures explained in the following paragraphs if the incident was detected within the maximum of a five(5)minutes period that was played in the match (*useful play time, if applicable*), after the irregularity occurred.
 - 1.2. If the irregularity occurred outside the rink - *either noticed by the Assistant Referee himself or notified to him through a complaint presented by a team's delegate* -the Auxiliary Referee will call the Main Referees to her/his presence and inform them of the incident, either profiting a natural stop of the match or taking the initiative of causing the game to stop, using a whistle.
 - 1.3. If the incident perceived has direct or indirect effect on the course and/or result of the game- *not noticed irregular substitution, excluded or suspended player who unduly participated in play, 10th team foul not sanctioned with a direct free hit, etc.* -the Main Referees must always to review the facts among them and - *if it is the case* - to agree on the correction they think is pertinent.
 - 1.4. When any one of the periods of a match was finished - *either before the corresponding game time is completed or before an error that needs rectification had been detected* -the Main Referees will have to ensure, if necessary, that the teams return to the rink and order the restart of the game based on the error to be rectified (*in case of an error in the control of play time, a neutral kick will be executed in the middle of the rink to restart the match*).
2. Relevant correction procedures may involve both technical sanctions - *execution or repetition of a direct free, for example* -as disciplinary punishments of potential offenders and their teams, involving the following actions:
 - 2.1. **First**, the MAIN REFEREES must guarantee the accuracy of the remaining playing time - *after having previously agreed with the AUXILIARY REFEREE and the TIMEKEEPER* -ensuring that it is rectified -*before the two teams and, if applicable* , in the electronic information board to the public -the information on the time of the match that was missing when the irregularity occurred.
 - 2.2. **After**, the MAIN REFEREES have to ensure that all actions taken in the match- *after the playing time that has been eliminated are cancelled* - considering the following particularities:
 - 2.2.1. When the refereeing error had an impact only on disciplinary matters, due to the improper display of one or more red cards- *for example, if the referees had sanctioned an alleged irregular substitution, which was later proven not to have occurred* -they must be cancelled.
 - 2.2.2. When a refereeing error only affects matters of a technical nature, **the subsequent decisions will be cancelled**- *including possible goals obtained by any of the teams, but with the exception of any red cards that have been directly displayed*- **taking into account that all the sanctions related to the teams of the offenders remain cancelled**(*the team will not have to play a "period in inferiority"*).
3. When - *after being confronted with a claim on a possible error*- the MAIN REFEREES decide that no correction is justified, the resumption of the match will have to be assured based on the interruption that took place to clarify the situation.
4. Nevertheless, the MAIN REFEREES will always have to report- *in a "Confidential Report"* -all the claims made during the match regarding any irregularities and/or refereeing errors, detailing their nature and the basis of the decisions made, including - *if the case* - the information on the correction procedures that were carried out.



ARTICLE 37 - PRESENTATION OF PROTESTS

1. ADMINISTRATIVE PROTESTS

- 1.1 “Administrative protests” are motivated by irregularities or violations - *bad state of the rink, deficient markings on the rink, irregular goal cages, etc.* -of the Technical Rules.
- 1.2 To be considered valid, “administrative protests” must be notified to the Main Referees of the game - *by the team Delegate and by the team Captain* -before the start of the match.
- 1.3 When receiving an “administrative protest”, the Main Referees will act as follows:
 - 1.3.1 Inform the delegate and captain of the opposite team of the protest.
 - 1.3.2 On the official Match Report - *on the place identified as “Declaration of protest”* - write the grounds of the protest, and, immediately afterwards, the delegates and captains of both teams must sign it.
 - 1.3.3 Proceed to the identification and examination of the alleged irregularities - *together with the delegates and captains of both teams* - in order to confirm if the protest is pertinent and, if so, if they can be corrected and/or if they compromise the taking place of the game.
- 1.4 When the Main Referees consider that the match cannot take place on the premises, they must immediately proceed as specified in paragraph 5 of Article 5 of these Rules.
- 1.5 In any case, the Main Referees must draft a separate Confidential Report, complementary to the official Match Report, writing down all steps and decisions taken concerning the protest.

2. TECHNICAL PROTESTS

- 2.1 “Technical protests” are motivated by “law errors”- *alleged “false judgements” or technical errors of refereeing* - that may have been committed by the Main Referees in the game.
- 2.2 To be considered valid, a “technical protest” must be notified on the rink *by the team captain* to the Main Referees of the game, making use of a stoppage in the game or immediately after the end of the game.
- 2.3 When receiving a “technical protest”, the Main Referees will act as follows:
 - 2.3.1 Inform immediately the captain of the other team *or, in her/his absence, the second captain*, of the intent to protest the game.
 - 2.3.2 Write on the official Match Report the grounds of the protest- *on the place identified as “Declaration of protest”* -and immediately afterwards, make the delegates and captains of both teams sign the official Match Report.

3. CONFIRMATION OF PROTESTS AND / OR COMPLAINTS

All protests, both “administrative” and “technical”, must afterwards be confirmed by the body responsible for the team that filed the protest- *Federation or Club* -per official letter - *accompanied by the means of payment of the corresponding fee* -that has to be sent to:

- 3.1 The **ORGANIZING ENTITY OF THE COMPETITION**; and
- 3.2 The entity that has jurisdiction over the event, i.e.:
 - 3.2.1 **WORLD SKATE-RHTC** or **CONTINENTAL CONFEDERACIÓN**, in the case of an international competition
 - 3.2.2 The **FEDERATION OF AFFILIATION**, in the case of a national competition.



CHAPTER X- FINAL AND TRANSITIONAL PROVISIONS

ARTICLE 38 - APPROVAL, ENTRY INTO FORCE AND FUTURE CHANGES

1. After obtaining the favourable opinion of the World Skate Rink Hockey Technical Commission, the Rules of the Game and its appendix (*the Rink Hockey Technical Regulation*) have been jointly approved by **WORLD SKATE** and by **WORLD SKATE - RINK-HOCKEY TECHNICAL COMMISSION (WS-RHTC)**.
2. **The Rules of the Game and the Technical Regulation now approved are mandatory in all the Rink Hockey competitions organized either by World Skate and the Continental Confederations or by the affiliated National Federations.**
 - 2.1 The breach of this provision by any National Federation shall determine the formal participation of WS-RHTC addressed to the Executive Board of **WORLD SKATE**, in order to establish the corresponding sanction, without prejudice to the established in the following paragraph.
 - 2.2 In any case, the National Federation in question shall be preventatively suspended from all the international rink-hockey competitions under the supervision of WS-RHTC and/or of the Continental Confederation of its affiliation.
3. The Rules of the Game and the Technical Regulation of Rink-Hockey that are now approved shall formally enter into force on the following dates:
 - a) **2018, SEPTEMBER 1**, in all the rink-hockey competitions organized by **WORLD SKATE EUROPE** and by its respective affiliated National Federations;
 - b) **2019, JANUARY 1**, in all the rink-hockey competitions organized by WS-RHTC, by the other Continental Confederations (*WORLD SKATE AFRICA, WORLD SKATE AMERICA, WORLD SKATE ASIA and WORLD SKATE OCEANIA*) and by their respective affiliated National Federations.
4. Any proposal to change that may be submitted in future, regarding the Rules of the Game and the Technical Regulation shall always be previously submitted to the approval of **WORLD SKATE-RHTC**.



ANNEX

RINK-HOCKEY TECHNICAL REGULATION

Summary/Index

CHAPTER I - PREMISES OF THE GAME - RINK MARKINGS AND INSTRUMENTS

Article 1	THE PREMISES AND THE RINK	Pages 60 and 61
Article 2	MARKINGS ON THE RINK	Pages 61 and 62
Article 3	THE GOAL CAGE	Pages 62 and 63
Article 4	THE BALL	Page 64
Article 5	ADVERTISEMENT ON THE RINK AND ON THE INNER SIDE OF THE FENCE	Page 64

CHAPTER II - REFEREES - EQUIPMENT USED, SIGNS AND MATCH SHEETS

Article 6	UNIFORM AND ACCESSORIES USED BY REFEREES IN THE GAME	Page 65
Article 7	REFEREES' SIGNS	Pages 66 to 69
Article 8	OFFICIAL MATCH SHEETS - PROCEDURES TO BE ACCOMPLISHED	Pages 70 and 71

CHAPTER III - EQUIPMENT, PROTECTION AND TOOLS USED BY PLAYERS

Article 9	BASIC PLAYER'S EQUIPMENT	Pages 72 and 73
Article 10	GOALKEEPERS' PROTECTION EQUIPMENT	Pages 73 to 76
Article 11	OPTIONAL PLAYERS' PROTECTION EQUIPMENT	Pages 76 to 78
Article 12	ADVERTISING ON PLAYERS' EQUIPMENT	Page 78

CHAPTER IV - ORGANIZATION OF INTERNATIONAL EVENTS

Article 13	ORGANIZING ENTITIES OF INTERNATIONAL EVENTS	Page 79
Article 14	OBLIGATORY PRECAUTIONS IN THE ORGANIZATION OF ANY EVENT	Page 79

TECHNICAL REGULATION ANNEXES

ANNEX 1	MARKINGS OF THE RINK	Page 81
ANNEX 2-A	GOAL CAGE DESIGN (LATERAL + FRONT VIEW)	Page 82
ANNEX 2-B	DRAWING OF THE GOAL CAGE (HORIZONTAL VIEWS)	Page 83



CHAPTER I - PREMISES OF THE GAME - RINK MARKINGS AND INSTRUMENTS

ARTICLE 1 - THE PREMISES AND THE RINK

1. The premises of the game comprise the rink, dressing rooms, and all accesses to them.
2. The rink has a flat and smooth surface made of an approved material, non-slippery and allowing good skate adhesion, such as wood, cement or other.
3. The rink has a rectangular shape and must always respect a “2:1 size ratio”. Size of the rink may range between:
 - 3.1 Minimum: 34 meters by 17 meters;
 - 3.2 Maximum: 44 meters by 22 meters.
4. The rink is surrounded by a closed barrier, 1 meter high, and has four semi-circular corners, with a radius between a maximum of 3 meters and a minimum of 1 meter.

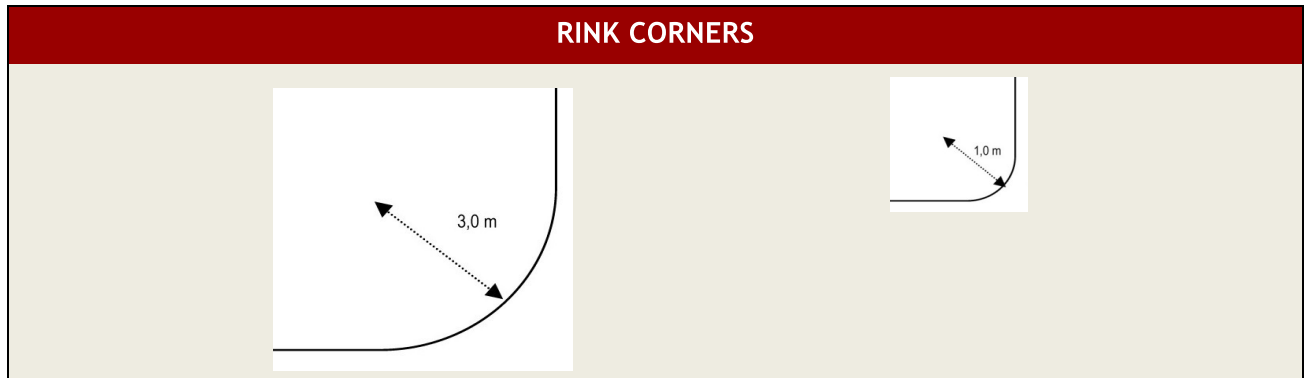

5. For the barrier, different solutions are possible:
 - 5.1 Opaque white coloured vertical panels integrally fabricated in hard plastic.
 - 5.2 Vertical posts, solidly anchored in the ground, with:
 - 5.2.1 **Wooden boards**, 20 centimetres high and 2 centimetres thick, forming the base of the barrier, painted in a neutral colour different from the colour of the ball.
 - 5.2.2 A structure of wood, wire netting, transparent plastic, with or without a rail, that rests on the boards.



- 5.3 Behind the end barrier, protection nets must be hung 4 meters high, measured from the floor.

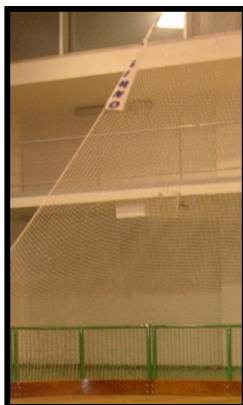

- 5.4 Along the barrier, there are two entrances to the rink - *that do not open towards the inside* - situated near each reserve benches



6. In the international championships for nations the rinks must have a standard size of 40 by 20 meters, and semi-circular corners with a 3 meters radius.
- 6.1 In club events - *both nationally and internationally* - the rinks must respect the provisions in paragraph 3 above.
- 6.2 National Federations may approve rinks the size of which has a 10% margin of error regarding the size specified in paragraph 3 above

ARTICLE 2 - MARKINGS ON THE RINK

1. The rink is marked according to the diagram hereunder and as specified in this article:

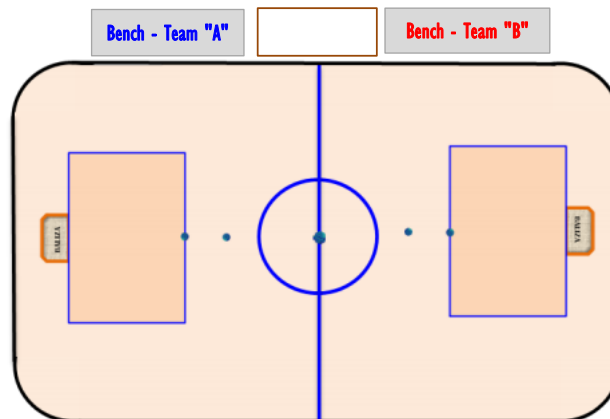

2. The standard markings on each half of the rink must be done as established in the ANNEX 1 of this Regulation.
- 2.1 All markings - *which are full part of the area or zone that is delimited by them* - must contrast with the colour of the ball and of the rink itself, to ensure they are perfectly visible.
- 2.2 In international events of national teams, the rink may not have other markings but the specific Rink-Hockey markings.
- 2.3 In all other events, the rink may have other markings, provided they do not hinder the good visibility of the specific Rink-Hockey markings.
3. **PENALTY AREA:** The penalty area is a rectangle marked on each half of the rink by four lines - *which are full part of it* - marked as follows:
- 3.1 Two lines parallel to the end boards, 9 meters long
- 3.2 Two lines parallel to the side boards, 5, 40 meters long
4. **GOAL-LINE:** The line between the two posts of the goal cage it is 1,7 metres long and marked at a minimum distance of 2,70 meters and a maximum of 3,3 meters from the end boards of the rink.
5. **GOALKEEPER'S PROTECTION AREA:** It has the form of a half-circle drawn from post to post, the centre of which is the middle of the goal-line of each goal-cage.
6. **PENALTY SPOT:** Circular spot - *with a diameter of 10 centimetres* - marked on the front line of each penalty area, at 5,40 meters perpendicularly on the centre of the goal-line.
7. **DIRECT FREE HIT MARKS:** Circular spot - *with a diameter of 10 centimetres* - marked on each half of the rink, at 7, 40 meters perpendicularly on the centre of the goal-line.



8. **HALFWAY LINE:** The line across the rink, parallel to the end barrier, which divides the rink in two halves and, for each team, in two “playing zones”:
- 8.1 The “defensive zone”, where the players must be when a centre pass is taken, either at the start or restart of the game (*after the interval*), or after a goal having been scored.
 - 8.2 The “attacking zone” corresponds to the “defensive zone” of the opposite team.
9. **CENTRE CIRCLE:** Marked on the centre of the rink, it has a 3 meters radius. When a centre pass is taken, the members of the other team may not be inside the circle
10. **MARK TO START AND RESTART THE GAME:** Circular spot - *with a diameter of 10 centimetres* - marked on the centre of the centre circle of the rink, on the halfway line that divides the rink

ARTICLE 3 - THE GOAL CAGE

1. All the relevant measures for the drawing of the goal cage are established in the ANNEX 2 of this Regulation.



2. The Rink-Hockey goal cage consists of a frame of hollow galvanised standard iron tube, made of three distinct parts welded together:
- 2.1 The front frame, painted in fluorescent orange, is composed of:
 - 2.1.1 Two vertical tubes - *the goal-posts* - joined at the top by a horizontal tube - *the cross-bar*.
 - 2.1.2 The goal posts and crossbar have an external diameter of 7,5 centimetres.
 - 2.1.3 The top corners of the cage should be cut at 45° (*forty-five degrees*), seen from the front.

THE CORNERS OF THE GOAL CAGE - DESIGN + “DETAIL” PHOTO

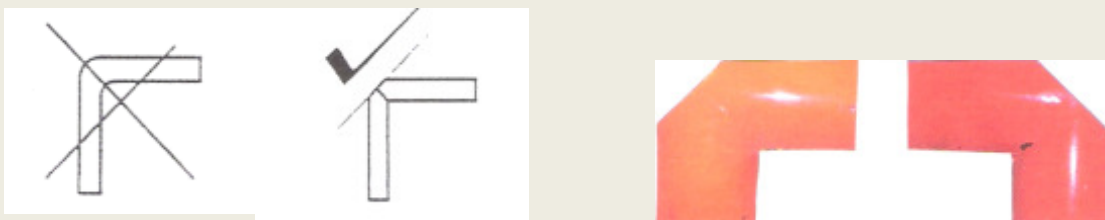

- 2.1.4 The distance from the floor to the inner edge of the cross-bar is 102,5 centimetres and the distance between the inner edges of the goal-posts is 170 centimetres.
- 2.2 The lower rear structure, painted in white, is composed of a semi-circular arch connected by a horizontal bar:
- 2.2.1 The tube forming the semi-circular arch - *which is welded to the front frame* - has a 5 centimetres diameter and a 64 centimetres radius on the centre of the goal-line.



- 2.2.2 The horizontal bar has size of 12 centimetres, is welded to the semi-circular arch parallel to the goal-line - at 25 centimetres - and with an inclination of 20° degrees from the floor.
- 2.3 The upper rear structure, painted in white, is composed of a rectangle with a semi-arch:
- 2.3.1 The rectangle and semi-arch are made of standard iron with a 1,5 centimetres diameter, welded to the front frame.
- 2.3.2 The four sides of the rectangle are formed by:
- Two horizontal bars, with a 40 centimetres length, welded to the superior part of each of the goal-posts;
 - The cross-bar of the front frame and a longitudinal bar with a 170 centimetres length, which is welded to the two horizontal bars
- 2.3.3 The semi-arch is welded to the rear corners of the rectangle. A transversal bar of 65 centimetres joins the semi-arch with the cross-bar of the front frame.
3. The rear structure of the cage is covered with a white net, mesh size 2,5 x 2,5 centimetres.
- 3.1 The net should be made of rope, cotton or nylon. Metal netting is not allowed.
- 3.2 The net must be fixed to the front frame and close the top, back and sides on the rear of the cage as well as the whole perimeter of the arch on the ground, to prevent that the ball enters the cage from outside in or leaves the cage through the back.
4. A second white netting, also mesh size 2,5 x 2,5 centimetres, is suspended on the inside of the cage to reduce the possibility of the ball bouncing back out of the cage.
- 4.1 Made of cotton or nylon - *lighter than the outer netting* - this net is fixed at the upper rear frame of the cage and is pending freely to the ground, parallel to the goal-line at distance of 40 centimetres from it.
- 4.2 This net is 110 centimetres high and 180 centimetres wide
5. The goal cages are placed one in front of the other, on the goal-line of each half of the rink, the centre of the cage exactly on the middle of the goal-line.

THE GOAL CAGE - LATERAL AND FRONTAL VIEWS (see Annex 2.A)



THE GOAL CAGE - HORIZONTAL VIEW (see Annex 2.B)

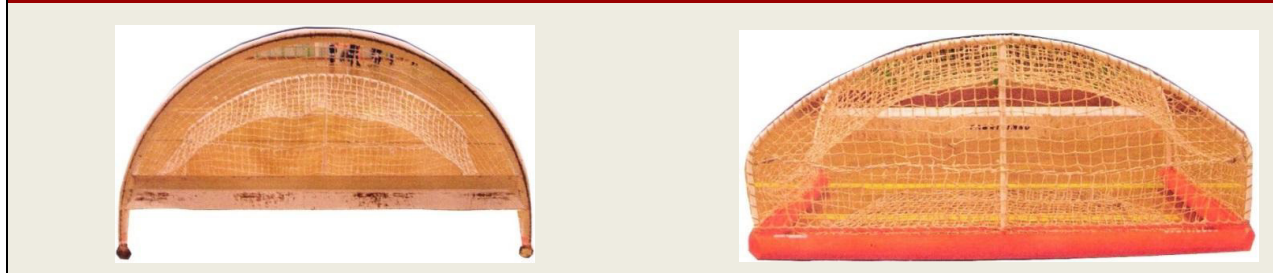

ARTICLE 4 - THE BALL

1. In all official Rink-Hockey competitions the ball used will be officially approved by the **WORLD SKATE RINK HOCKEY COMMISSION (WS-RHTC)**, and have the following characteristics:
 - 1.1 The official ball is made of pressed cork, weighs 155 grams, is perfectly spherical and has a 23 centimetres circumference.



- 1.2 The official ball of the game is of one colour - *preferably black or orange but may vary* - contrasting with the colour of the rink, markings and boards.
- 1.3 When a game is transmitted on television, the organiser of the event may impose the colour of the ball to be used in this specific game.
2. In case of disagreement between the captains of both team on the choice of the ball to be used - *or if no kind of official ball is provided* - the Main Referees will decide which ball to be used. He will choose the one that seems to him to be the most perfect sphere and have the least elasticity.

ARTICLE 5 - ADVERTISEMENT ON THE RINK AND ON THE INNER SIDE OF THE FENCE

1. In international events of national selection teams of the **WORLD SKATE member countries**, any kind of advertisement is allowable on the floor of the rink, as established in the following points.
 - 1.1 In international clubs' competitions, the organiser may allow one of his sponsors to place advertisements on the rink, inside the centre circle, provided the material used does not affect skates' adherence and motion.
 - 1.2 In addition to paragraph 1.1 above, national Federations may approve advertisement on other playing areas - *except inside the penalty areas* - and as long as they do not interfere visually with the markings of the rink.
2. It is allowed to place advertising panels or posters on the inside of the fence, if a minimum distance of 30 centimetres from the floor is kept free.
3. Paintings, advertising panels or posters on the inside of the fence may never constitute a danger or a hindrance to the players' action on the rink.



CHAPTER II - REFEREES - EQUIPMENT USED, SIGNS AND MATCH SHEETS

ARTICLE 6 - UNIFORM AND ACCESSORIES USED BY REFEREES IN THE GAME

1. The equipment to be used, either by the MAIN REFEREES of the game, or by the AUXILIARY REFEREE or by the ASSISTANT REFEREE, includes:
 - 1.1 A shirt or t-shirt, in which it must be placed - *on the chest, on the left side* - the official badge, considering that:
 - a) In world competitions, the International Referees must use the official logo of the **WS-RHTC**;
 - b) In the continental competitions, the International Referees must use the official insignia of their Confederation;
 - c) In the national competitions, the official Referees of each National Federation must use the respective insignia.
 - 1.2 Pants, Stockings and Sneakers with rubber outsole



2. The MAIN REFEREES of the game are also obliged to be carriers of the following instruments:
 - 2.1 A whistle of the official model approved by **WS-RHTC**.
 - 2.2 Two cards - *one blue and one red* - with dimensions of 12 x 9 centimetres
 - 2.3 A pen and a specific sheet for recording the disciplinary action taken during the match
 - 2.4 A watch or chronometer and a handkerchief
3. The colours used in the equipment of the MAIN REFEREES of each match cannot be confused with the colours of the equipment used by any of the teams
 - 3.1 In games conducted by two MAIN REFEREES, they will have to use equipment of the same colour.
 - 3.2 The AUXILIARY REFEREE and/or the ASSISTANT REFEREE may use a shirt or t-shirt of an equal or different colour from that used by the Main Referees



4. Advertising inserts - *from different companies or brands* - are allowed in the equipment used by the Rink-Hockey Referees, complying with the following limitations:
 - 4.1 Two advertising strips to be inserted in the shirt, one in the front and one in the back
 - 4.2 An advertising reference to insert in each of the sleeves
5. In all the world competitions, the use of publicity in the equipment of the referees is the exclusive responsibility of **WORLD SKATE**.



ARTICLE 7 - REFEREES' SIGNS

The MAIN REFEREES will use the signs as specified in the Rules of the Game and Technical Rules to command the players on the rink. Their gestures must be clear, as illustrated by the following figures.

1. **POSSESSION TIME OF THE BALL BY EACH TEAM IN ITS "DEFENSIVE ZONE"**

When a team has possession of the ball in its "defensive zone", the Main Referees must count the time - *one arm at waist height* - making a sideways movement for each second.



2. **TIME OUT**

To signal a "Time-out", the Referee will place one hand horizontally over the other hand held vertically, also with the palm open.



3. **FACE-OFF**

To order a « face-off », the Referee will raise one arm, palm of the hand to the front, and two fingers open (to form a "V"), while the other arm points to the place where the face-off is to be taken



4. **"ADVANTAGE LAW"**

It is not compulsory to signal the "ADVANTAGE LAW", to indicate that the game may go without interruption. However, the Referees may choose to do so, holding both arms before him - *forming a 60° angle with his body* - palms upwards.



5. WARNING ABOUT THE PRACTICE OF “PASSIVE PLAY”

5.1 THE “WARNING”

When an offensive team incurred in the practice of passive play, it is required that one of the Main Referees holds up the 2 (two) arms, warning that the offensive team has only 5 (five) seconds to conclude its offensive action, making a shot at the opponent’s goal cage.



5.2 “COUNTING” THE TIME OF BALL POSSESSION

In games with two Main Referees, immediately after one Referee warns for « passive play », the other Referee - *using the appropriate signals set out in paragraph 1 of this article* - must count the 5 (five) seconds in which the shot to the opposite cage must take place. If this doesn't take place, the Referee must whistle to stop the game.



6. PENALTY IN A CORNER OF THE PENALTY AREA

To signal that the ball must be put in a corner of the penalty area, the Referee will lift both arms above his head, joining fingertips, to form a lozenge.



7. INDIRECT FREE HIT

To signal an indirect free hit, the Referee will:

- a) With one arm stretched ... point to the place where the ball has to be put for the hit to be taken;
- b) With the other arm ... point to the offending team’s half of the rink



8. TEAM FOULS

The Referee who signals the foul raises one arm up to instruct the OFFICIAL TABLE OF THE GAME to register a team foul, while, at the same time, he points the direction of the offending team's half of the rink.

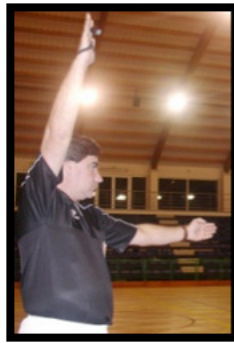

9. DISCIPLINARY ACTION (AWARD OF CARDS)

9.1 DISCIPLINARY ACTION - MOMENT 1

Before showing a card, the Referee must isolate the offender and oblige him to place himself at approximately 2 (two) meters. After that, he will show the adequate card, putting his arm (with the card) in an upright position.



9.2 DISCIPLINARY ACTION - MOMENT 2

After showing the card, the Referee will let the timekeeper's table know the shirt number of the offender, to leave no doubts (when the offender is not a player, the Referee will inform the OFFICIAL TABLE OF THE GAME who is the team representative)



9.3 DISCIPLINARY ACTION - MOMENT 3

Afterwards the Referee will point to the offender's team half of the rink - with one arm horizontally in a 90° angle with his body - to inform the timekeeper's table to which team the offender belongs.



10. INDICATION TO THE OFFICIAL TABLE OF THE GAME OF THE PLAYER WHO SCORED A GOAL

To signal a "goal", the referee will have to whistle and - *after pointing towards the centre of the rink* -she/he must clearly indicate to the OFFICIAL TABLE OF THE GAME which is the dorsal number of the player who scored the goal, to be registered at the official Match Report.



11. PENALTY SHOT AND DIRECTS FREE HIT

11.1 PENALTY SHOT AND DIRECTS FREE HIT - MOMENT 1

To signal a « direct free hit » or a « penalty shot », the Referee will proceed to the respective mark on the rink, pointing to the spot where the ball must be placed.



11.2 PENALTY SHOT AND DIRECTS FREE HIT - MOMENT 2

Except for the player executing the shot and the goalkeeper of the offending team, all other players are placed in the penalty area of the executing team, under supervision of one of the Main Referees. This Referee gives the signal to the other Referee that he may start procedures



11.3 PENALTY SHOT AND DIRECTS FREE HIT - MOMENT 3

The Referee who supervises the hit raises one arm to let the player know that he can start. With his other arm, the Referee who supervises the hit counts the 5 seconds granted to take the penalty.



ARTICLE 8 - OFFICIAL MATCH SHEETS - PROCEDURES TO BE ACCOMPLISHED

1. OFFICIAL MATCH SHEETS AND INFORMATION TO BE REPORTED

The MAIN REFEREES must register and report all the important incidences of any match on the following official formularies:

- The **OFFICIAL MATCH REPORT**
- The **MATCH CONTROL**
- The **TEAM LICENCES CONTROL**
- The **CONFIDENTIAL REFEREEING REPORT**

2. MAIN INFORMATION TO BE REPORTED BY THE MAIN REFEREES

For each game officially recognised by WS-RHTC, the Referees must register on the official match sheets the following information:

- 1.1 Place, date and time of the beginning and end of game.
- 1.2 Final score, as well as the goals scored by each team in each period of the game.
- 1.3 The roll of the players of both teams, with the number of their licence or ID document that was used to confirm their identification, as well as:
 - 1.3.1 The Player's shirt number
 - 1.3.2 The Function of the players, indicating specifically:
 - a) The Goalkeepers,
 - b) The team Captain and the Substitute Captain
 - 1.3.3 The players that score the goals
- 1.4 The roll of the other team representatives registered in the game, with the number of their licence or ID document that was used to confirm their identification, as well as their functions, according to the limits established in paragraph 2.2. of Article 8 of these Rules.
- 1.5 Disciplinary measures taken by the Main Referees during the game, on players and other team members, and specification of cards applied (*blue and/or red*).
- 1.6 The number of team fouls assigned to each team.
- 1.7 Time-outs requested by the teams in each period of the game.
- 1.8 Information on any declaration of protest submitted to the Main Referees by any of the teams, duly signed by its Captain.

2. Must also be identified:

- 2.1 The Refereeing team designated for the match (*Main Referees, Auxiliary Referee, Assistant Referee and Timekeeper*)
- 2.2 The remaining persons present at the Official Table, with the specification of their post.
- 2.3 The Technical Delegate officially designated for evaluating the Refereeing performance

3. Immediately after the end of the game, the official match sheets must be signed by the Captains of both teams.

- 3.1 If the team captain and/or substitute captain refuse to sign the Match Report, the Main Referees must write a Confidential Report of the facts.
- 3.2 If the team captain and the substitute captain have been expelled, the Match Report will be signed by the player who was designated to act as team captain.

4. All the members of the Refereeing team designated for the game will sign the "OFFICIAL MATCH REPORT", after carefully checking what is registered and after indicating if any additional relevant information will be followed later by them - *in a specific and complementary "Confidential Refereeing Report"* - according to what is established hereunder, in paragraph 5 of this Article.

5. CONFIDENTIAL REFEREEING REPORT

- 5.1 Only to be produced when there are serious or specific situations to be reported, or when there is need for complementary information in order to guarantee an exact, objective and accurate description of the relevant facts occurred in the game.
- 5.2 In particular, the following situations must always be reported:



- 5.2.1 The exhibition of red cards, with a detailed description of the infractions, circumstances and motives, detailing specifically:
- a) The offences or injurious terms uttered.
 - b) The cases of gross or violent behaviour - *such as aggressions and/or reactions to aggressions* - and details of how they were conducted - *punching, kicking, hitting with the stick, etc.* - and which part of the body was hit.
- 5.2.2 When a match did not take place or when it was ended before the proper time, with a clear description of the motives and circumstances that determined the Main Referees' decision.
- 5.2.3 Cases of force majeure or situations in which the physical integrity of the Referees was threatened and caused them to leave the rink/premises.
- 5.2.4 **Any deficiencies or irregularities detected by the Referees in the equipment and/or the protections used by any player and/or goalkeeper**, informing what the steps taken to rectify the situation and the result thereof, that is:
- **If the situation was regularized and the player or the goalkeeper was authorized to play the game;** or
 - **If the situation was not regularized and the player or the goalkeeper was not allowed to play the game.**



CHAPTER III - EQUIPMENT, PROTECTION AND TOOLS USED BY PLAYERS

ARTICLE 9 - BASIC PLAYER'S EQUIPMENT

1. The Rink-hockey players will use the following basic equipment:
 - 1.1 **Shirt, shorts and socks**, as specified in paragraph 4 below.
 - 1.2 **Boots with skates**, as specified in paragraph 5 below.
 - 1.3 **A stick**, as specified in paragraph 6 below.
2. The goalkeeper must wear specific protective equipment, as specified in Article 10.
3. The players, as well as the goalkeepers, can use several protections, according to the provisions in Article 11.
4. The shirts, shorts and socks used by the floor players will be in the colours of the country or club they are representing. The goalkeepers must wear a shirt of a different colour, but not to be confounded with the opposite team's colours (*including the goalkeeper's*).
 - 4.1 All players' shirts, as well as the goalkeepers', must bear a different number: from 1 (one) to 99 (ninety-nine).
 - 4.1.1 Numbers are marked on the back of the shirt, in a colour contrasting with the colours of the shirts and never less than 30 (*thirty*) centimetres high.
 - 4.1.2 Without prejudice of the above paragraph, numbers may also be marked on the front of the shirts and shorts.
 - 4.2 Regardless of the numbers used by goalkeepers, they must be registered as such on the Match Report.
 - 4.3 When both teams - *and the goalkeepers of both teams* - show up on the rink with the same colours or colours that lend themselves to confusion, the Main Referees will proceed as follows:
 - 4.3.1 Try to come to an agreement between the teams.
 - 4.3.2 When no agreement is reached, the home team - *or considered as such on the official calendar* - must change the colour of their equipment, including, if necessary, the goalkeeper's.
 - 4.4 The team captain will wear an identifying armband of a different colour than his shirt.
 - 4.4.1 When the team captain is substituted, he will not have to pass his armband to his team-mate but must inform the Main Referees of who will replace him as captain on the rink.
 - 4.4.2 When the team captain is expelled - *or when he is injured and not able to remain in the game* - his armband will be passed to the substitute captain registered as such on the Game Sheet.
5. Players must wear boots with 4 (*four*) wheels, placed two by two on two transversal axles. No in-line skates are permitted in Rink-Hockey.
 - 5.1 No kind of metallic protection is allowed on the boots, even if covered by some other kind of material.
 - 5.2 The wheels may not have a diameter less than 3 (*three*) centimetres. No kind of supplementary protection is allowed between the front and back wheels.
 - 5.3 The use of toe stops on the toe of the boots or skates is allowed but may not have a diameter of more than 5 (*five*) centimetres, and if they are not a danger for the other players.

SKATES USED BY THE RINK FLOOR PLAYERS



- 5.4 Goalkeepers may use skates with smaller wheels, to improve their stability when defending the goal cage.



6. The stick used by the players - *goalkeepers included* - must comply with the following requirements:
- 6.1 The stick must be made of wood or plastic, or other material previously approved by WS-RHTC. Metal and metal reinforcements are not permitted. The use of adhesive tape or strips of cloth is allowed.
- 6.2 The blade of the stick must be flat on both sides. The full length of the stick measured on the outside of the curve must comply with the following measures:
- 6.2.1 Maximum length: 115 (*one hundred and fifteen*) centimetres
- 6.2.2 Minimum length: 90 (*ninety*) centimetres
- 6.3 The stick must be able to go through a ring with a 5 (*five*) centimetre diameter, and its weight may not exceed 500 (*five hundred*) grams.



- 6.4 Goalkeepers are allowed to play with an alternative "stick" model, as represented in the following image.



ARTICLE 10 - GOALKEEPERS' PROTECTION EQUIPMENT

1. In addition to the previous Article, goalkeepers are required to wear the following protection equipment:
- 1.1 A full head protection mask or a helmet and visor, as specified in paragraph 2 below.
- 1.2 A chest pad, as specified in paragraph 3 below.
- 1.3 Two goalkeeper's gloves, as specified in paragraph 4 below.
- 1.4 Two leg guards, as specified in paragraph 5 below.



2. The full head protection helmet and helmet and visor used by the goalkeepers are made of one or two separate pieces in rigid plastic or other material, fixed to each other with straps. When there are metal parts in them, these must be adequately covered (*with plastic, leather or rubber*), in order not to endanger the physical integrity of the other players.



3. The chest pad must be worn underneath the shirt. It is made of one piece - *and includes shoulder and upper arm protection* - in sufficiently flexible material to fit around the body. Thickness of padding may never exceed 1,5 (*one point five*) centimetres.



- 3.1 The use of the following protection equipment for goalkeepers is optional:
- 3.1.1 Throat protector, adjusted to the neck, with a maximum height of 5 (*five*) centimetres, fitted underneath the chest pad.
 - 3.1.2 Thigh protector, elastic or semi-rigid, worn as a sleeve over the thigh, with a maximum thickness of 0,5 (*zero point five*) centimetres.
- 3.2 It is not allowed, in any case, the placement of any other material, allowing the user to increase the natural dimensions of the aforementioned protections
4. The goalkeeper's gloves are made of flexible material, such as leather, cloth, canvas, synthetic or plastic materials, approved by the WS-RHTC. The use of metal parts within or outside metal covering is forbidden, as well as of other materials that may endanger the physical integrity of the person using it or of the other players.
- 4.1 The goalkeeper's gloves must protect hands and part of the fore-arms. Their form and fabric must not necessarily be identical, if they comply with the following measures:
- 4.1.1 Maximum length of the glove forty (*40*) centimetres
 - 4.1.2 Maximum width with thumb spread..... twenty-five (*25*) centimetres
 - 4.1.3 Maximum width of 4 fingers spread twenty (*20*) centimetres
 - 4.1.4 Maximum thickness five (*5*) centimetres



4.2. One of the gloves must be flexible and articulate, to allow the goalkeeper to hold and handle the stick.



4.3 The other glove may be less flexible, but it must allow the hand to remain open, with the fingers spread and separate.



5. The goalkeeper's leg guards must be made of leather - or other *WS-RHTC approved material* - in one piece, or two pieces linked together, and fixed with straps around the legs, in order to ensure partial protection of legs and feet.

5.1 The goalkeeper's leg guards must comply with the following maximum measures:

- 5.1.1 Width at the top 30 (thirty) centimetres
- 5.1.2 Width in the middle 27,5 (twenty-seven and a half) centimetres
- 5.1.3 Width at the bottom 25 (twenty-five) centimetres
- 5.1.4 Total height 65 (sixty-five) centimetres
- 5.1.5 Thickness all over 5 (five) centimetres



- 5.2 The foot protection may, or not, be an individual piece separate from the leg guard, but it may never lengthen the leg guard's maximum size of 65 (*sixty-five*) centimetres.
 - 5.2.1 The foot protection has a maximum width of 25 (*twenty-five*) centimetres, adjusted to the bottom of the leg guard, and has side reinforcements of maximum 11 (*eleven*) centimetres high and 20 (*twenty*) centimetres high between the extremities lengthwise.
 - 5.2.2 Maximum thickness allowed is 5 (*five*) centimetres.
 - 5.2.3 These protections must be wrapped around the legs and feet, independently, and fastened by means of 2 (*two*) or 3 (*three*) straps, that may be fitted through the front or sides of the guards.
- 5.3 Goalkeeper's guards may be made of leather, cloth, canvas, synthetic or plastic materials. They must be flexible and are not allowed to have - *either inwardly or outwardly* - metal or other materials that may endanger the physical integrity of goalkeepers and other players.
6. The goal-keepers 'protection equipment must be certified by the entity that is responsible for the organisation of competitions, both internationally (*WS-RHTC or Continental Confederation, as it is the case*) and nationally (*by the respective Federations*).

ARTICLE 11 - OPTIONAL PLAYERS' PROTECTION EQUIPMENT

1. All players, including the goalkeeper, can wear non-metal protective equipment, placed directly over their body and totally adjusted to it, to preserve exclusively their physical integrity and provided it does not give them any kind of unfair advantage in the game.
2. Players are permitted to use the following protective equipment:
 - 2.1 Padded gloves, with a maximum thickness of 2,5 (*two point five*) centimetres, fingers totally separated, and a maximum length of 10 (*ten*) centimetres from the pulse to the forearm.

PLAYERS' GLOVES



- 2.2 Cushioned knee pads, with a maximum thickness of 2,5 (*two point five*) centimetres, for the exclusive protection of the knees

PLAYERS' KNEE PADS



- 2.3 Shin guards, with a maximum thickness of 5 (*five*) centimetres, to be worn under the socks and wrapped around the legs.



- 2.4 Coquille, in textile or resistant plastic material for protection of genitals.



- 2.5 Elbow pads, of a non-rigid material that cannot endanger other players..

3. PROTECTION OF THE HEAD OR OF THE FACE OF A PLAYER

- 3.1 When - *for reasons of injury to the head or face* - a player needs to use special protection, the entity having jurisdiction of the event - **WORLD SKATE-RHTC** or *Continental Confederation* or *National Federación* - may grant the corresponding exceptional authorization, after the following procedures have been met:

3.1.1 **Submission of a formal demand by the player for the use of a special protection**, in which he/she must present:

- a) **A statement signed by a doctor**, indicating the reasons that recommend the use of a protection and the period of time in which it is necessary;
- b) **The presentation of a photo with the protection to be used by the player in question.**

3.1.2 In front of such a demand, the entity that has the jurisdiction of the competition will formally approve (*or not*) the use of the proposed protection, by means of a certifiable document sent to the player in question - *registered letter or email* - of that will be given knowledge to his team and also to the Referees and officers that will manage the competition.

- 3.2 Considering any future demand, it is important to clarify the **two models of protection whose use may be consented**, once the procedures established in the previous point have been complied with

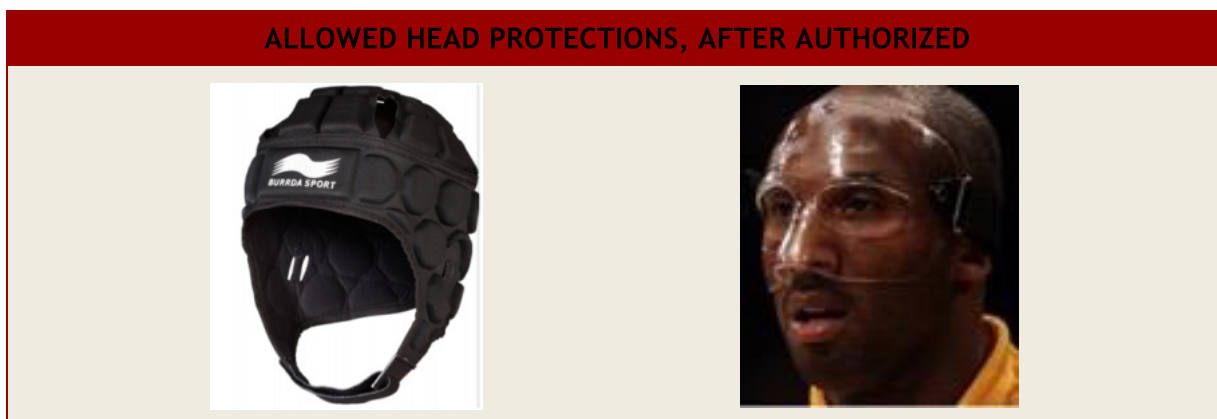

- 3.3 However, it is important to recall that it is clearly established that - *in any of the roller hockey competitions* - the use of helmets on the head is not allowed, which - *being produced with rigid or semi-rigid material* - constitute an indisputable danger to the physical integrity of the other players on the rink.

ARTICLE 12 - ADVERTISING ON PLAYERS' EQUIPMENT

1. Advertising is allowed on the players' uniform, if it does not hinder the correct identification of the team's basic colours.
2. Advertising on players' equipment may be from commercial sponsors or brands, but any kind of political or religious propaganda is entirely forbidden.

ADVERTISING ON PLAYERS' EQUIPMENT



CHAPTER IV - ORGANIZATION OF INTERNATIONAL EVENTS - COMPULSORY PRECAUTIONS

ARTICLE 13 - ORGANIZING ENTITIES OF RINK-HOCKEY INTERNATIONAL EVENTS

1. Any international Rink-Hockey event - *either for nations or for clubs* - can only be organized by a National Federation affiliated in WORLD SKATE, based on a formal proposal that - *depending on the cases* - is previously and duly approved by:
 - 1.1 **WORLD SKATE - RINK HOCKEY TECHNICAL COMMISSION**, in the case of world competitions, official or not, in which there is the participation of nation or club teams of the affiliated National Federations in the different Continental Confederations.
 - 1.2 **TECHNICAL COMMISSION OF RINK-HOCKEY OF EACH CONTINENTAL CONFEDERATION**, in the case of continental competitions, official or not, in which there is the participation of nation or club teams of the affiliated National Federations in the same Continental Confederation.
2. However, the organizing National Federation may propose to hold the event in question in cooperation with one or more clubs and/or with one or more public or private institutions, options that will have to be formalized together with the entity that is responsible for its approval.

ARTICLE 14 - OBLIGATORY PRECAUTIONS IN THE ORGANIZATION OF ANY EVENT

The National Federation and/or another entity to which the organization of a championship, tournament or any other rink-hockey event is attributed are obliged to ensure the following precautions:

1. **SAFETY PRECAUTIONS**

- 1.1 The organizing entity of any rink-hockey competition - *National Federation and/or other* - is responsible for ensuring the good development of all matches, which means that all incidents caused by the public and/or other causes must be immediately repressed.
- 1.2 Consequently, the organizing entity must always ensure the following **precautions**:
 - 1.2.1 It is mandatory for the duration of the entire event, the permanent presence in the event precinct of a security force, whether public or private,
 - 1.2.2 It is necessary to ensure the protection of the zone of each team bench and the zone where the OFFICIAL GAME TABLE is located - *whose access must be delimited by the placement of barriers or static separators* - in order to avoid the launching of objects and / or other problems with the public.

2. **MEDICAL PRECAUTIONS**

- 2.1 In any rink-hockey event, it is compulsory to have in the sporting premises, during all the days of the competition, the following medical equipment and conditions:
 - 1.2.3 A "defibrillator", at least;
 - 1.2.4 A "medical office" duly prepared for the realization of "doping controls";
 - 1.2.5 A "medicalized ambulance", in a place of easy access, outside the facilities;
 - 1.2.6 A doctor in "permanent service", inside the event venue, during all the matches
- 2.2 In addition to all this, the information (*address and contacts*) about the hospital that is closest to the sport facilities of the event should be available in a clearly visible place.

3. **INSURANCE CONTRACTS**

In order to deal with any accidents that may occur in the different matches of any rink-hockey event, which may cause damage or prejudice, either in the facilities and/or to the equipment in use in the sports arena, or in the people present (*referees, players and other team representatives, institutional members, spectators, officials and volunteers in service*), **it is mandatory to contract the following insurances**:

- 1.1 **Workers' compensation insurance**, for all the officials and volunteers in service at the event;
- 1.2 **Civil liability insurances**, to cover possible damages and prejudices that may affect:
 - a) the team representatives, the referees, the managers and other international officers, and officials of the organizing and the international entities and the public;
 - b) the facilities and the equipment used in the event
- 1.3 **Personal accident insurances**, in order to prevent the eventual injuries that can occur, either with the Referees, players and other team representatives and members of the sporting authorities or to the spectators, officials, employees and volunteers that are in service at the event.



ANNEXES

1. MARKINGS ON THE RINK (EACH HALF)
- 2.A DRAWING OF THE GOAL CAGE (*LATERAL + FRONTAL VIEWS*)
- 2.B DRAWING OF THE GOAL CAGE (*HORIZONTAL VIEWS*)



ANNEX 1 - MARKING ON THE RINK

Article 3 Technical Rules

Marking on the Rink (each Half)

M=1:125

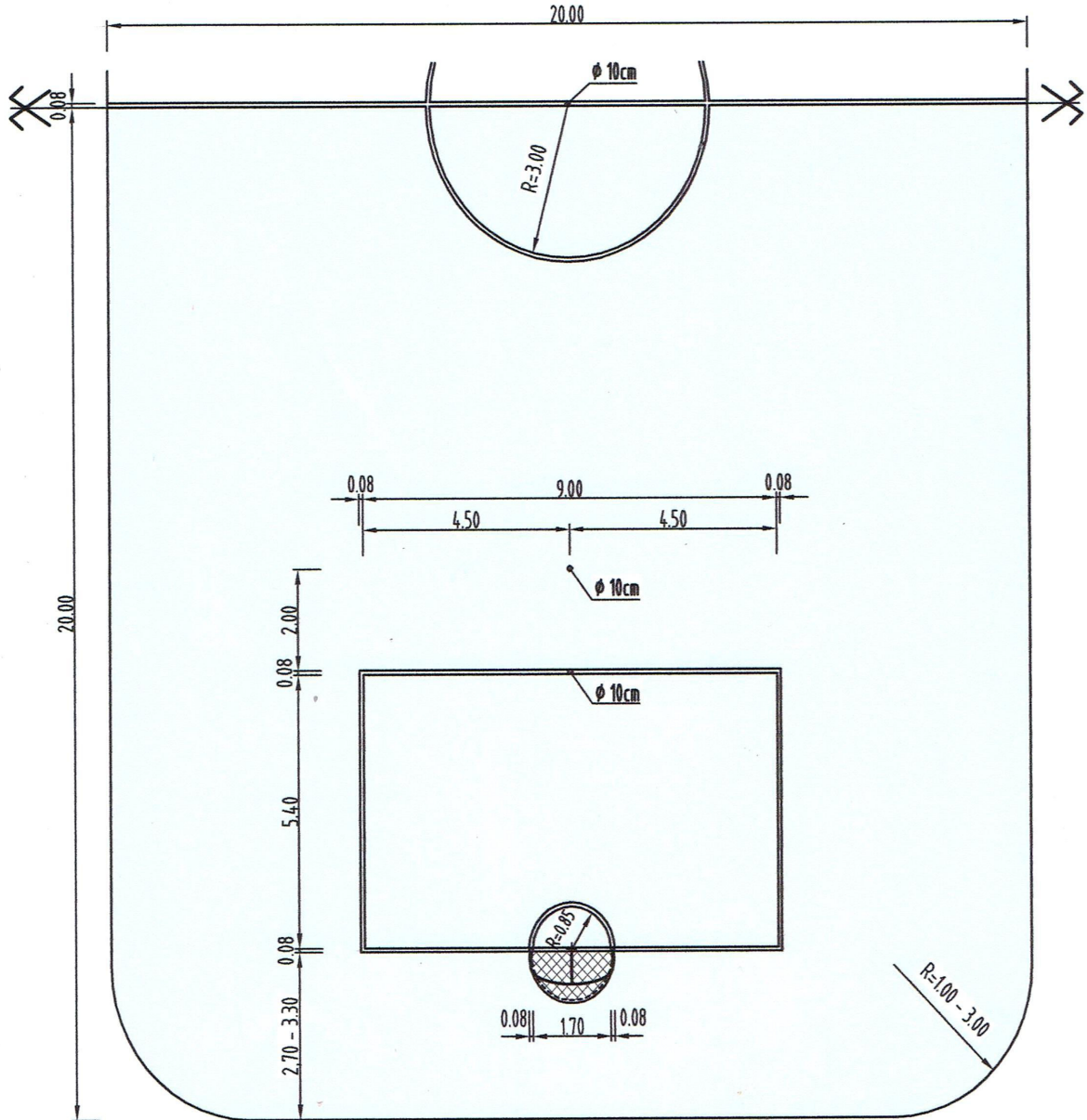

ANNEX 2.A - DRAWING OF GOAL CAGE

Goal Cage

Lateral view

M=1:10

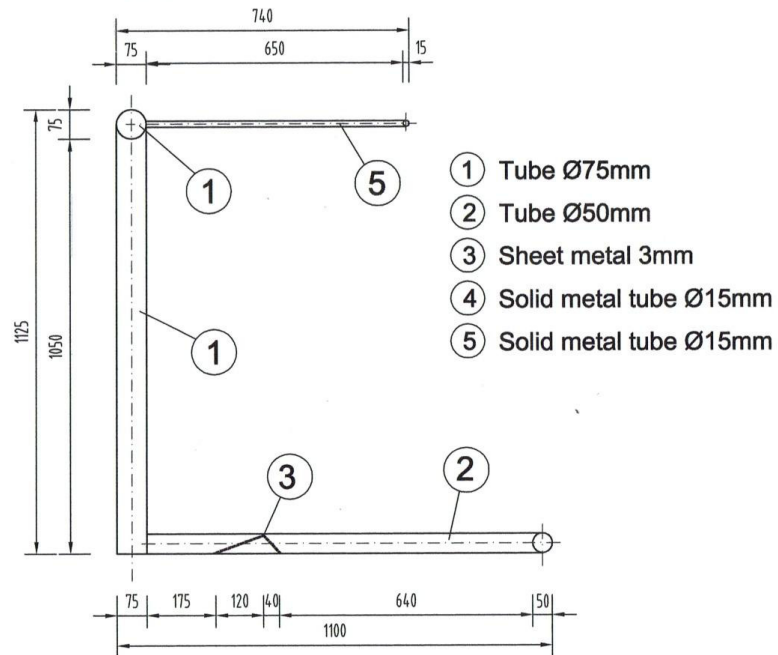

Goal Cage

Front view

M=1:10

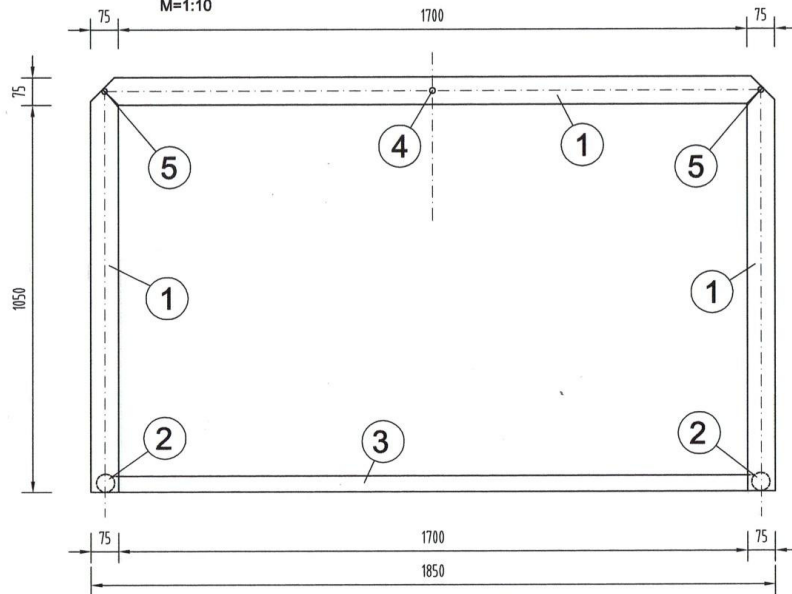

ANNEX 2.B - DRAWING OF GOAL CAGE

Goal Cage
Horizontal Projection (floor)
M=1:10

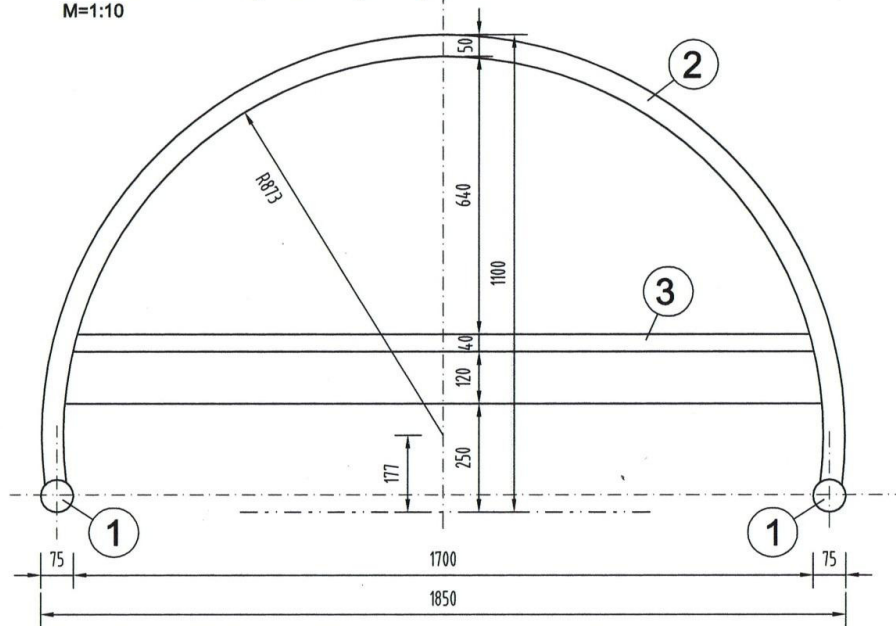

Goal Cage
Horizontal Projection
M=1:10

